



**Product Info**  
**Sheets**



Product Information Sheets  
**Modular Range** Configurable furniture  
**Preconfigured Range** Preconfigured furniture



**Modular Ranges**  
Configurable Furniture

**Preconfigured range**  
Preconfigured furniture



### Stock'Alli Range



### Supply Range



### Mod'Alli Range



### Accessories



### Options



### Logist'Alli Range



### Components



### Organisation Range





Modular product



Options					
2 roller wheels Ø 75 ref. OP-M2110500 2 roller wheels Ø 100 ref. OP-M2110700	Offset ergonomic handle ref. OP-POIGNEE	Side rail (x4) ref. OP-RAIL	Back Covering: One colour: Volcanic black ref. OP-GUFONDNOIR	Side finish: 7 colour choices ref. OP-GUDG ref. OP-GUDGNOIR	Colour range: 7 colour choices (See Colour Information Sheet)

**A wide range of components is available.**  
(See components information sheet)

**A wide variety of accessories is available.**  
(See accessory information sheet)

Specific configurations



**Description**

Steel frame, tubular U-section  
Volcanic Black epoxy enamel  
ABS PMMA tray, 30 mm edges borders on three sides,  
4 thermoplastic swivel castors, including 2 with  
brakes, 125 mm Ø with non-marking rubber

**Stock'Alli  
Trolley**

Features		Ref.: MO-GU	
Construction	<b>Welded</b>	Front section	<b>600</b>
Materials	<b>Steel</b>	75 drawer capacity	<b>9</b>
Available colours	<b>1</b>	50 basket capacity	<b>12</b>
Locking system	<b>N/A</b>	MDDC capacity	<b>12</b>
Empty weight	<b>13kg</b>	P20 System No.	<b>36</b>

**Use:** Lightweight and flexible, the trolley can be easily adapted to your desired configuration. The P20 system allows you to create a custom configuration to suit your specifications. All our accessories and components can be used with this cart. The EasyClean system makes the cleaning process easy.

The  
Preconfigured  
Range

# Stock'Alli Trolley

Ready to go

With 20 years of experience serving healthcare facilities, we have analysed and designed optimum configurations to meet your needs and expectations



**Trolley with 2 shelves** Ref.: PP-GU2P

Configuration	Level
Shelf with raised protective rim on three sides (H30mm)	Level 1
Sliding shelf with raised protective rim on 3 sides	Level 2



**Trolley with 2 shelves and 1 drawer (H155mm)** Ref.: PP-GU2PIT

Configuration	Level
Shelf with raised protective rim on three sides (H30mm)	Level 1
Drawer 155 - with compartments	Level 2
Sliding shelf with raised protective rim on 3 sides	Level 3



**Trolley with 3 shelves** Ref.: PP-GU3P

Configuration	Level
Shelf with raised protective rim on three sides (H30mm)	Level 1
Sliding shelf with raised protective rim on 3 sides	Level 2
Sliding shelf with raised protective rim on 3 sides	Level 3



**Trolley with 3 shelves and 1 drawer (H75mm)** Ref.: Ref. PP-GU3PIT

Configuration	Level
Shelf with raised protective rim on three sides (H30mm)	Level 1
Drawer 75 - with compartments	Level 2
Sliding shelf with raised protective rim on 3 sides	Level 3
Sliding shelf with raised protective rim on 3 sides	Level 4

**Treatment trolley** Ref.: Ref. PP-GUV1

Configuration	Quantity
Offset ergonomic handle	
Easy-clip rail	
Back panel	
Drawer 75 - with 30 compartments	Level 1
Drawer 75 - with 20 compartments	Level 2
Drawer 155 - with 18 compartments	Level 3
Drawer 155 - with 12 compartments	Level 4
Drawer 235 - without compartments	Level 5
Accessories	
Waste bin (12 litre capacity)	1
Waste bin holder	1





Modular product



**Options**



2 roller wheels Ø 75  
ref. OP-M2110500  
2 roller wheels Ø 100  
ref. OP-M2110700



Digicode keypad lock:  
ref. OP-LS100 (no card)  
ref. OP-LS200 (with card)  
(See Locking System Information Sheet)

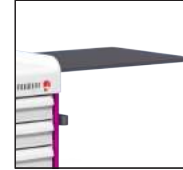

Sliding shelf left/right  
ref. OP-TABL

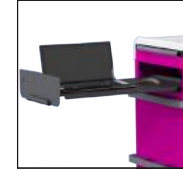

Secure laptop compartment  
ref. OP-CTSP0



Colour range:  
7 colour choices  
(See Colour Information Sheet)

**A wide range of components is available.**  
(See components information sheet)

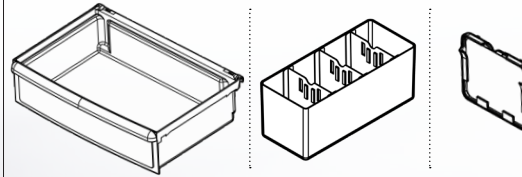

**A wide variety of accessories is available.**  
(See accessory information sheet)

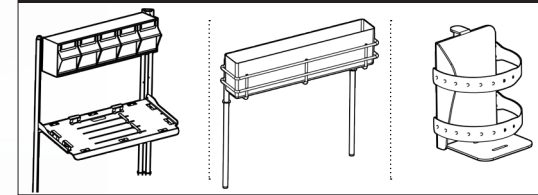

*Specific configurations*



Ref. PP-M21000V1



Ref. PP-M21000V2



Ref. PP-M21000V3

**Description**

One-piece aluminium frame  
Epoxy painted finish available in 7 colours  
ABS PMMA tray, 30 mm raised protective edges on three sides,  
4 thermoplastic swivel castors, including 2 with brakes,  
125 mm Ø with non-marking rubber  
4 EasyClip side rails

**Mod'Alli**  
Treatment cart

Features		Ref. : MO-M21000	
Construction	<b>One-piece frame</b>	Front section	<b>600</b>
Material	<b>Aluminium</b>	75 drawer capacity	<b>9</b>
Available colours	<b>7</b>	50 basket capacity	<b>12</b>
Locking system	<b>Option</b>	MDDC capacity	<b>12</b>
Empty weight	<b>18kg</b>	P20 System No.	<b>36</b>

**Use:** The EasyMov system reduces the physical effort necessary for use, making this cart a real asset in your daily routine. Combined with the P20 system, which offers optimally organised storage for healthcare items, it is an ideal treatment cart solution. The EasyClip design makes it easy to attach accessories according to the needs of each department.

ALLIBERT MEDICAL S.A.S 9, Avenue des Trois Fontaines, CS 20503. 95015 Cergy-Pontoise CEDEX  
Tel.: +33 (0) 1 34 43 43 10. Tel.: +33 (0) 1 34 43 43 11 **Email: [contact@allibert-medical.com](mailto:contact@allibert-medical.com)**  
Items may differ from images - reproduction prohibited. Allibert Medical reserves the right to make changes to its products based on technological development.





# Mod'Alli Treatment Cart

Ready to go

With 20 years of experience serving healthcare facilities, we have analysed and designed optimum configurations to meet your needs and expectations

The  
Preconfigured  
Range



**Treatment Cart equipment** Ref: PP-M21000V1

Configuration	
Sliding shelf on left/right	
Handle	
Drawer 75 - with 30 compartments	Level 1
Drawer 75 - with 20 compartments	Level 2
Drawer 155 - with 18 compartments	Level 3
Drawer 155 - with 12 compartments	Level 4
Drawer 235 - without compartments	Level 5

Accessories	Quantity
Cristal label holder, 60 x 47 (in batches of 50)	1
12 litre waste bins for selective waste sorting (set of 2)	1
Sharp container holder	1



**Treatment cart with computer compartment** Ref: PP-M21000V2

Configuration	
Digicode keypad LS100	
Sliding shelf on left/right	
Secure laptop compartment	
Drawer 75 - with 30 compartments	Level 1
Drawer 75 - with 20 compartments	Level 2
Drawer 155 - with 18 compartments	Level 3
Drawer 155 - with 12 compartments	Level 4
Drawer 235 - without compartments	Level 5

Accessories	Quantity
Cristal label holder, 60 x 47 (in batches of 50)	1
12 litre waste bins for selective waste sorting (set of 2)	1
Sharp container holder	1

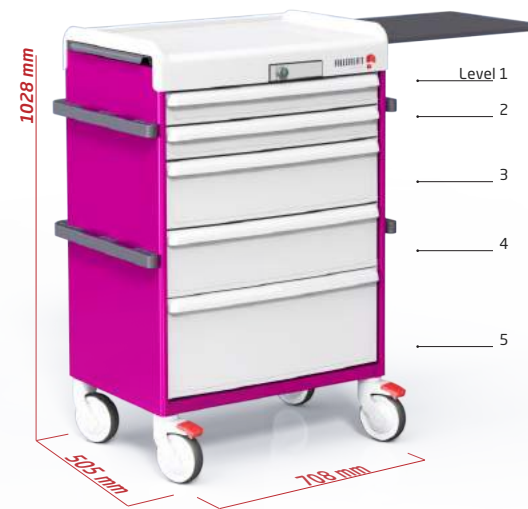

**Treatment cart** Ref: PP-M21000V3

Configuration	
Digicode keypad LS100	
Sliding shelf on left/right	
Drawer 75 - with 30 compartments	Level 1
Drawer 75 - with 20 compartments	Level 2
Drawer 155 - with 18 compartments	Level 3
Drawer 155 - with 12 compartments	Level 4
Drawer 235 - without compartments	Level 5



**Modular product**



**Options**



2 roller wheels Ø 75  
ref. OP-M2110500  
2 roller wheels Ø 100  
ref. OP-M2110700



Digicode keypad lock:  
ref. OP-LS100 (no card)  
ref. OP-LS200 (with card)  
(See Locking System Information Sheet)



Sliding shelf left/right  
ref. OP-TABL



Secure laptop compartment  
ref. OP-CTSP0



Colour range:  
7 colour choices  
(See Colour Information Sheet)

**A wide range of components is available.**  
(See components information sheet)

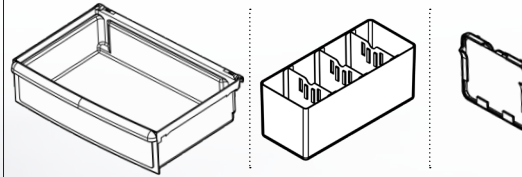

**A wide variety of accessories is available.**  
(See accessory information sheet)

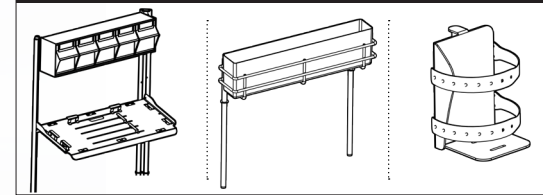

*Specific configurations*



Ref. PP-M21000ANV2



Ref. PP-M21000ANV1

**Description**

One-piece aluminium frame  
Epoxy painted finish available in 7 colours  
ABS PMMA tray, 30 mm raised protective edges on three sides,  
4 thermoplastic swivel castors, including 2 with brakes,  
125 mm Ø with non-marking rubber  
4 EasyClip side rails

**Mod'Alli**  
**Anaesthesia Cart**

Features		Ref. : MO-M21000	
Construction	<b>One-piece frame</b>	Front section	<b>600</b>
Material	<b>Aluminium</b>	75 drawer capacity	<b>9</b>
Available colours	<b>7</b>	50 basket capacity	<b>12</b>
Locking system	<b>Option</b>	MDDC capacity	<b>12</b>
Empty weight	<b>18kg</b>	P20 System No.	<b>36</b>

**Use:** The anaesthesia cart, intended for use on OR floors, is easily decontaminated after every use, thanks to its EasyClean construction. The EasyClip design makes it easy to add specific accessories to the cart to maximise functionality and optimise work surface availability.

# Mod'Alli Anaesthesia Cart

Ready to go

With 20 years of experience serving healthcare facilities, we have analysed and designed optimum configurations to meet your needs and expectations

The  
Preconfigured  
Range

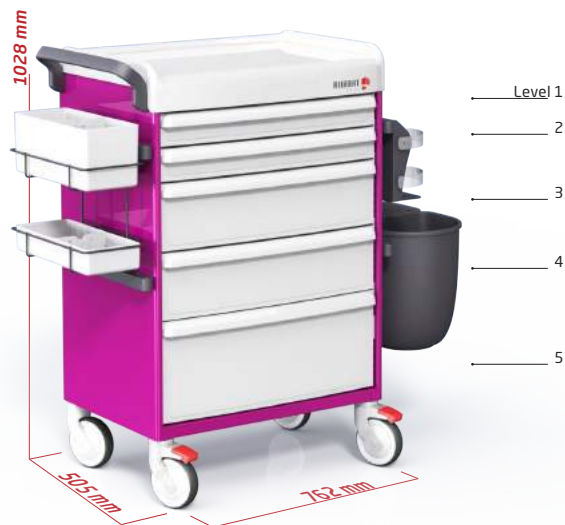

Anaesthesia Cart	Ref.: PP-MZ1000ANV1
Configuration	
Handle	
Drawer 75 - with 18 compartments	Level 1
Drawer 75 - with 8 compartments	Level 2
Drawer 155 - with 4 compartments	Level 3
Drawer 155 - with 4 compartments	Level 4
Drawer 235 - no compartments	Level 5
Accessories	
Side storage feature on 2 levels (+ 2 divider trays)	1
12L waste bin	1
Sharp container holder	1



Anaesthesia Cart	Ref.: PP-MZ1000ANV2
Configuration	
Digicode keypad LS100	
Handle	
Drawer 75 - with 18 compartments	Level 1
Drawer 75 - with 8 compartments	Level 2
Drawer 155 - with 4 compartments	Level 3
Drawer 155 - with 4 compartments	Level 4
Drawer 235 - no compartments	Level 5
Accessories	
Overbridge unit with 2 rows of tilting boxes (4 and 5 boxes per row)	1
12L waste bin	1
Sharp container holder	1
4-compartment catheter container	1





Modular product



Options

Labelling options  
ref. OP-ID

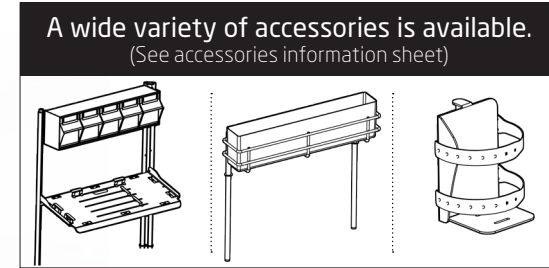
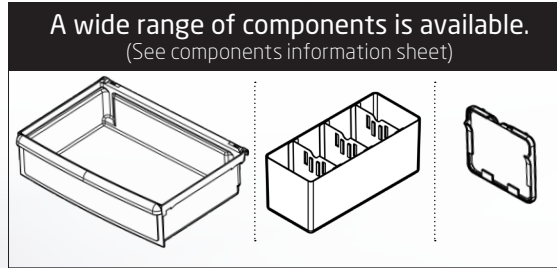

Specific configurations



Ref. PP-M21007UR1

Ref. PP-M21007UR2

Ref. PP-M21007UR3

**Description**

One-piece aluminium frame  
Epoxy painted finish in Red Fusion  
ABS PMMA tray, 30 mm raised protective edges on three sides,  
4 thermoplastic swivel castors, including 2 with brakes,  
125 mm Ø with non-marking rubber  
EasyClip rail, and central locking bar and seal system

**Mod'Alli  
Crash cart**

Features		Ref.: M0-M21007	
Construction	One-piece frame	Front section	600
Materials	Aluminium	75 drawer capacity	9
Available colours	7	50 basket capacity	12
Locking system	Option	MDDC capacity	12
Empty weight	19kg	P20 System No.	36

**Use:** Easily identifiable by its red colour and labelling, the emergency cart is specially configured and secured with a numbered seal locking system. Facilitates effective treatment response in cases of critical organ failure. Available in three versions, standard or customised.

ALLIBERT MEDICAL S.A.S 9, Avenue des Trois Fontaines, CS 20503. 95015 Cergy-Pontoise CEDEX  
Tel.: +33 (0) 1 34 43 43 10. Tel.: +33 (0) 1 34 43 43 11 Email: [contact@allibert-medical.com](mailto:contact@allibert-medical.com)  
Items may differ from images - reproduction prohibited. Allibert Medical reserves the right to make changes to its products based on technological development.





# Mod'Alli Emergency cart Ready to go

With 20 years of experience serving healthcare facilities, we have analysed and designed optimum configurations to meet your needs and expectations

The  
Preconfigured  
Range



### V1 Emergency cart (equipped)

Ref.: PP-M21007UR1

Configuration	Quantity
Drawer 75 - no compartments	Level 1
Drawer 75 - no compartments	Level 2
Drawer 155 - no compartments	Level 3
Drawer 155 - no compartments	Level 4
Drawer 235 - without compartments	Level 5
Accessories	Quantity
Central locking bar and seal system	1
Cardiac (CPR) board	1

### V2 Emergency cart (equipped)

Ref.: PP-M21007UR2

Configuration	Quantity
Drawer 75 - with 18 compartments	Level 1
Drawer 75 - with 8 compartments	Level 2
Drawer 155 - with 4 compartments	Level 3
Drawer 155 - with 4 compartments	Level 4
Drawer 235 - without compartments	Level 5
Accessories	Quantity
Central locking bar and seal system	1
Monitoring support	1
Serum holder	1
Cardiac (CPR) board	1

### V3 Emergency cart (equipped)

Ref.: PP-M21007UR3

Configuration	Quantity
Handle	Level 1
Drawer 75 - with 18 compartments	Level 2
Drawer 75 - with 8 compartments	Level 3
Drawer 155 - with 4 compartments	Level 4
Drawer 155 - with 4 compartments	Level 5
Drawer 235 - without compartments	Level 5
Accessories	Quantity
Central locking bar and seal system	1
Oxygen cylinder holder	1
Monitoring support	1
Cardiac (CPR) board	1
Serum holder	1

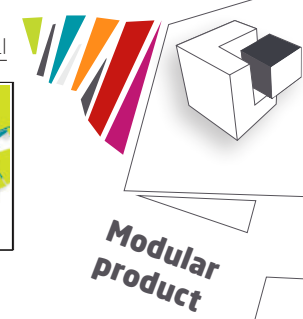

**Modular product**



**Options**



2 roller wheels Ø 75  
ref. OP-M2110500  
2 roller wheels Ø 100  
ref. OP-M2110700



Digicode keypad access lock with card  
ref. OP-LS200  
Standard model with digicode keypad LS100 (See Locking System Information Sheet)



Sliding shelf left/right  
ref. OP-TABL



Secure laptop compartment  
ref. OP-CTSP0  
(See Colour Information Sheet)

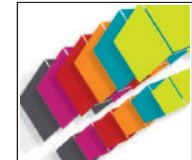

Colour range:  
7 colour choices  
(See Colour Information Sheet)

**A wide range of components is available.**  
(See components information sheet)

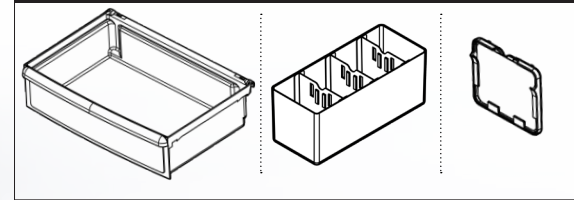

**A wide variety of accessories is available.**  
(See accessory information sheet)

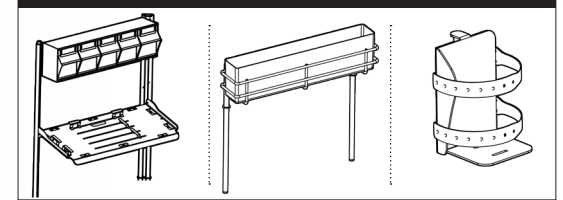

*Specific configurations*



**Description**

One-piece aluminium frame with epoxy painted finish available in 7 colours  
ABS PMMA tray, 30 mm raised protective edges on three sides,  
4 thermoplastic swivel castors, 2 with brakes,  
125 mm Ø with non-marking rubber  
Polypropylene (PP) roller shutter and digicode keypad LS100  
4 EasyClip side rails

**Logist'Alli Medication cart** (daily & weekly)

Features		Ref.: MO-M21001	
Construction	<b>One-piece frame</b>	Front section	<b>600</b>
Materials	<b>Aluminium</b>	75 drawer capacity	<b>9</b>
Available colours	<b>7</b>	50 basket capacity	<b>12</b>
Locking system	<b>LS100</b>	MDDC capacity	<b>12</b>
Empty weight	<b>22kg</b>	P20 System No.	<b>36</b>

**Use:** The EasyMov system reduces the physical effort needed in use, making this cart a real asset in your daily routine. Combined with the P20 system, it offers optimum space saving and organised storage for your products. Our components are adapted for individual and daily medication process. The No-Key Concept system works with a digicode keypad or access card, for more secure medication.

ALLIBERT MEDICAL S.A.S 9, Avenue des Trois Fontaines, CS 20503. 95015 Cergy-Pontoise CEDEX  
Tel.: +33 (0) 1 34 43 43 10. Tel.: +33 (0) 1 34 43 43 11 **Email: contact@alibert-medical.com**  
Items may differ from images - reproduction prohibited. Alibert Medical reserves the right to make changes to its products based on technological development.



## Logist'Alli

Medication cart (daily & weekly)

Ready to go

With 20 years of experience serving healthcare facilities, we have analysed and designed optimum configurations to meet your needs and expectations

The  
Preconfigured  
Range



### Labelled medication cart with digicode keypad

Ref.: PP-M21001V1

Configuration	
Handle	
Shelf + 6 drawer trays (1/6) with 4 separators	Level 1 to 3
Drawer 155 - with 4 compartments (4 trays)	Level 4
Drawer 155	Level 5
3- Accessories	Quantity
Sharp container holder	1
12L waste bins for sorted waste disposal	2



### Labelled medication cart with laptop stand and digicode keypad

Ref.: PP-M21001V3

Configuration	
Secure laptop compartment	
Handle	
Tray sets + 7 medium daily pillboxes tray with 4 separators	Level 1 to 9
Drawer 155 - with 4 compartments (4 trays)	10
3- Accessories	Quantity
Sharp container holder	1
12L waste bins for sorted waste disposal	2



Modular product



Central locking

17.3"

charger connection



Ergonomic design for laptop use with

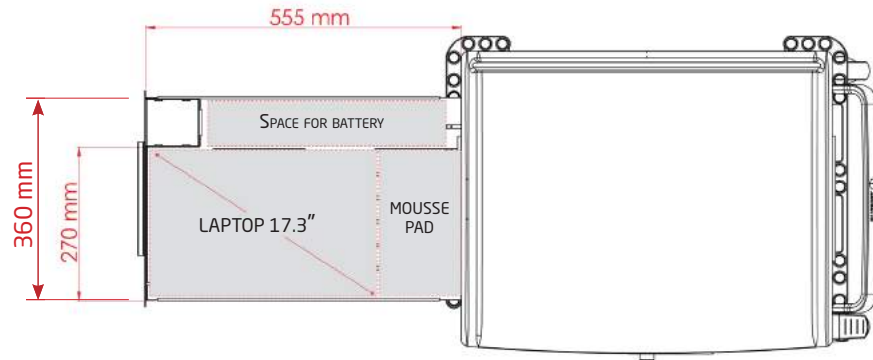

Charge laptop with compartment closed



## Options

### Secure laptop drawer compartment

Features	Ref.: OP-CTSP0
Fits laptops of up to:	17.3 inches
Mains power connection	✓
Central locking system	Centralized
Available colours	Volcanic black
EasyClean	✓
Laptop stand	✓

**Use:** Now as integral part of the unit, the secure laptop drawer compartment facilitates computer network and database access directly from the cart while keeping the full work surface clear for use. The digicode keypad allows you lock shutter and compartment simultaneously. For complete security, the laptop can be charged when the compartment is shut and locked.

## Options

### Sliding shelf

The optional sliding shelf in the Mod'Alli and Logist'Alli ranges doubles the size of your work surface. It can slide to the left or right and easily stored under the main top tray.



#### Mod'Alli

The shelf can be pulled out to the left or right

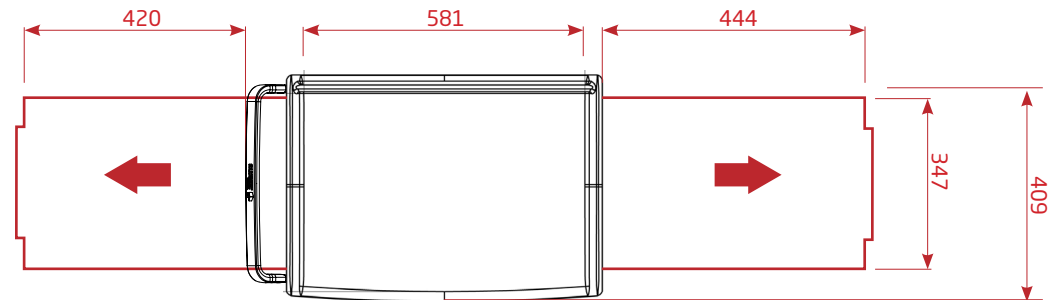

#### Logist'Alli

The shelf can be pulled out to the left or right

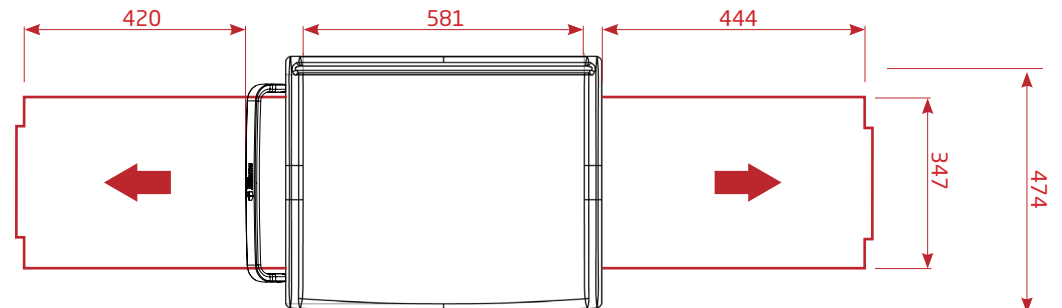

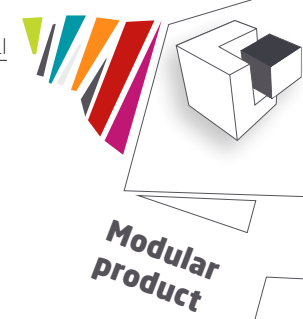

**Modular product**



**Options**



2 roller wheels Ø 75  
ref. OP-M2110500  
2 roller wheels Ø 100  
ref. OP-M2110700



Digicode keypad access lock with card  
ref. OP-LS200  
Standard model with digicode keypad LS100  
(See Locking System Information Sheet)



Colour range:  
7 colour choices  
(See Colour Information Sheet)

**A wide range of components is available.**  
(See components information sheet)

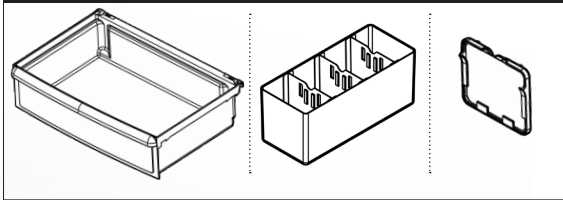

**A wide variety of accessories is available.**  
(See accessories information sheet)

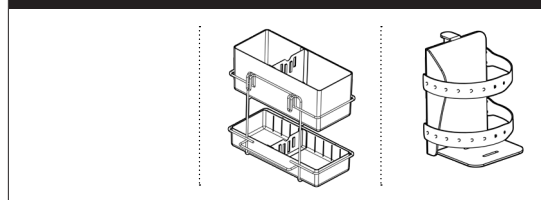

**Description**

One-piece aluminium frame  
Epoxy painted finish available in 7 colours  
ABS PMMA tray, 30 mm raised protective edges on three sides,  
4 thermoplastic swivel castors, 2 with brakes,  
125 mm Ø with non-marking rubber  
Polypropylene (PP) roller shutter and digicode keypad LS100  
EasyClip Rail

*Specific configurations*



Ref. PP-M21002V1



Ref. PP-M21002V2



Ref. PP-M21002V3

**Logist'Alli**  
Low mobile cabinet

Features		Ref.: MO-M21002	
Construction	<b>One-piece frame</b>	Front section	<b>600</b>
Materials	<b>Aluminium</b>	75 drawer capacity	<b>15</b>
Available colours	<b>7</b>	50 basket capacity	<b>20</b>
Locking system	<b>LS100</b>	MDDC capacity	<b>20</b>
Empty weight	<b>27kg</b>	P20 System No.	<b>60</b>

**Use:** Lightweight and compact, this mobile cabinet with roller shutter and digicode keypad lock offers maximum space-saving storage and security. It is the ideal solution for pharmacy cabinets, traditional stock or as specialised cabinets. Very easy to manoeuvre thanks to its EasyMov design, ideal for transport between units.



# Logist'Alli Mobile cabinet

Ready to go

With 20 years of experience serving healthcare facilities, we have analysed and designed optimum configurations to meet your needs and expectations

The  
Preconfigured  
Range



**Mobile cabinet with toxic/narcotic substances drawer** Ref.: 2v

Configuration	
Narcotics drawer 75	Level 1
Drawer 75	Level 2 to 9
Drawer 155 - with 4 compartments (4 trays)	Level 10 to 12



**Mobile cabinet with narcotic drawer** Ref.: PP-M21002V2

Configuration	
Narcotics drawer 75	Level 1
Drawer 75	Level 2 to 11
Drawer 155 - with 4 compartments (4 trays)	Level 12



**Mobile cabinet with drawers and shelves** Ref.: PP-M21002V3

Configuration	
Shelf	Level 1 and 2
Drawer 155	Level 3 and 4
Drawer 235	Level 5
Accessories	Quantity
Handle	1





**Modular product**



**Options**



2 roller wheels Ø 75  
ref. OP-M2110500  
2 roller wheels Ø 100  
ref. OP-M2110700



Digicode keypad lock:  
ref. OP-LS100 (no card)  
ref. OP-LS200 (with card)  
(See Locking System Information Sheet)



Colour range:  
7 colour choices  
(See Colour Information Sheet)

**A wide range of components is available.**  
(See components information sheet)

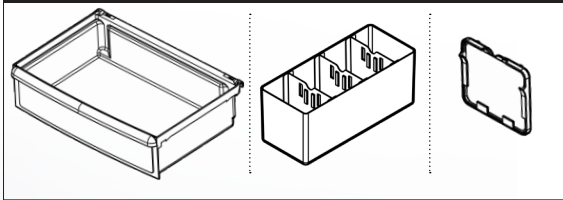

**A wide variety of accessories is available.**  
(See accessory information sheet)

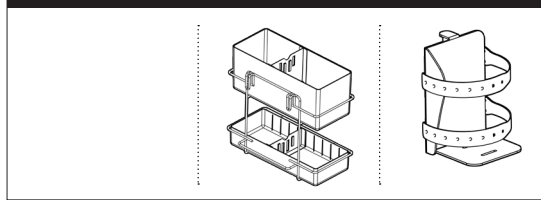

Specific configurations



Ref. PP-MOR1615V1

**Description**

One-piece aluminium frame  
Epoxy painted finish available in 7 colours  
ABS PMMA tray, 30 mm raised protective edges on three sides,  
4 thermoplastic swivel castors, 2 with brakes,  
125 mm Ø with non-marking rubber  
EasyClip Rail

**Mod'Alli**  
Low mobile cabinet

Features		Ref.: MO-MOR1615	
Construction	<b>One-piece frame</b>	Front section	<b>600</b>
Materials	<b>Aluminium</b>	75 drawer capacity	<b>15</b>
Available colours	<b>7</b>	50 basket capacity	<b>20</b>
Locking system	<b>Option</b>	MDDC capacity	<b>20</b>
Empty weight	<b>22kg</b>	P20 System No.	<b>60</b>

**Use:** This lightweight compact cabinet provides maximum capacity. The ideal solution for storing medical equipment, linens and IV fluids. Very easy to manoeuvre thanks to its EasyMov design, ideal for transport between units.

**Mod'Alli**  
Mobile cabinet

Ready to go

With 20 years of experience serving healthcare facilities, we have analysed and designed optimum configurations to meet your needs and expectations

The  
**Preconfigured  
Range**



**Nursing or storage cabinet** Ref.: *PP-MOR1615V1*

Configuration	Quantity
Locked drawer	Level 1
Drawer 155 - with 4 compartments (4 trays)	Level 2
Drawer 235 - with 4 compartments (4 trays)	Level 3 and 6
3- Accessories	Quantity
Foldable writing shelf	1



Modular product

Easy Secure®



Height of top drawer 1.64m

Choice of Options



Side rail (x4)  
ref. OP-RAIL

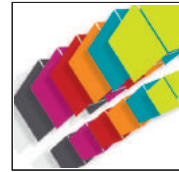

Colour range:  
7 colour choices  
(See Colour Information Sheet)

**MOTORISATION WARRANTY 5 YEARS**

A wide range of components is available.  
(See components information sheet)

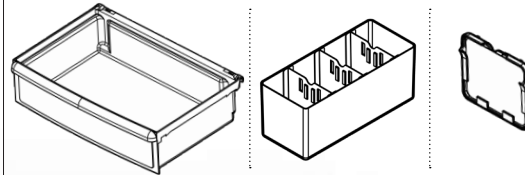

A wide variety of accessories is available.  
(See accessory information sheet)

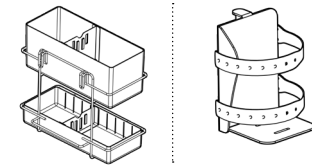

4 figure code to open shutter



Shutter opens automatically in 11 seconds



Programmable automatic closure

OR

Manual closure  
1 touch shutter closure

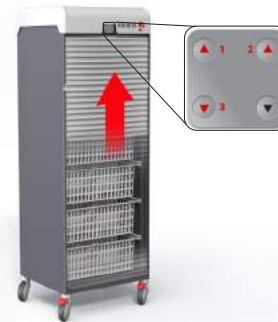

**Description**

130 cycle (open/close) battery life  
One piece stainless steel frame with epoxy painted finish in a choice of 7 colours  
4 swivel castors, 2 with brakes Ø 125 mm  
Empty weight: **60 kg**

**Logist'Alli**  
Cabinet with motorised roller shutter

Features		Ref.: MO-LOA600MO	
Construction	One-piece frame	Front section	600
Materials	Steel	75 drawer capacity	18
Available colours	7	50 basket capacity	24
Locking system	Command entry	MDDC capacity	24
Empty weight	60kg	P20 System No.	72

**Use:** Leave your security to us! A revolutionary product. This cabinet offers you fully motorised roller shutter operation. Equipped with a digital keypad, it has a self timer system which ensures that shutter closure is completely secured. Combined with the P20 system, which offers optimal organisation of storage for all essential items, it provides a storage solution with no wasted space.

ALLIBERT MEDICAL S.A.S 9, Avenue des Trois Fontaines, CS 20503. 95015 Cergy-Pontoise CEDEX  
Tel.: +33 (0) 1 34 43 43 10. Tel.: +33 (0) 1 34 43 43 11 Email: [contact@allibert-medical.com](mailto:contact@allibert-medical.com)  
Items may differ from images - reproduction prohibited. Allibert Medical reserves the right to make changes to its products based on technological development.



**Logist'Alli**  
Motorised roller  
shutter cabinet

Leave your security to us! A revolutionary product. This cabinet offers you fully motorised roller shutter operation.

**MOTORIZED  
WARRANTY  
5 YEARS**



**Motorised cabinet closure for  
100% automated security**

4 figure code  
to open shutter



Shutter opens automatically in  
11 seconds



Programmable automatic  
closure



or

Manual closure,  
1 touch shutter closure



**No more waiting for shutters to close!**



**Modular product**

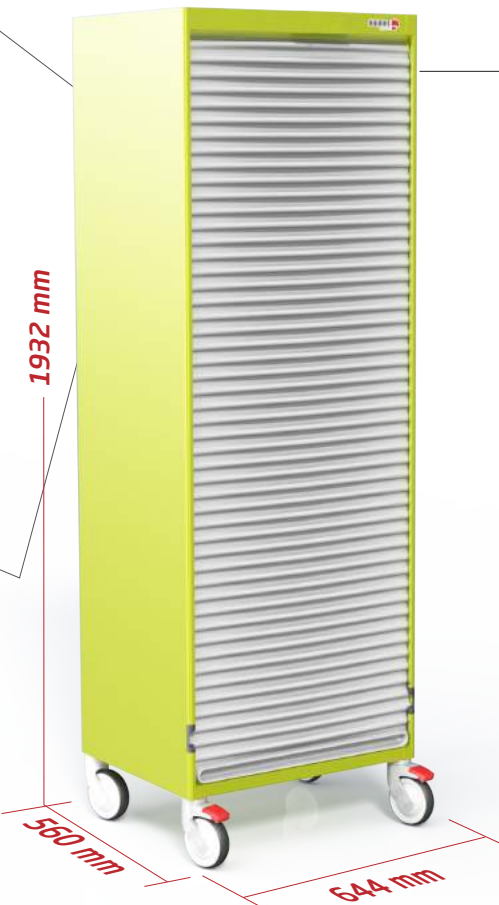

**Options**



2 roller wheels Ø 75  
ref. OP-M2110500  
2 roller wheels Ø 100  
ref. OP-M2110700



Digicode keypad lock:  
ref. OP-LS100 (no card)  
ref. OP-LS200 (with card)  
(See Locking System Information Sheet)

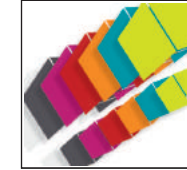

Colour range:  
7 colour choices  
(See Colour Information Sheet)

**A wide range of components is available.**  
(See components information sheet)

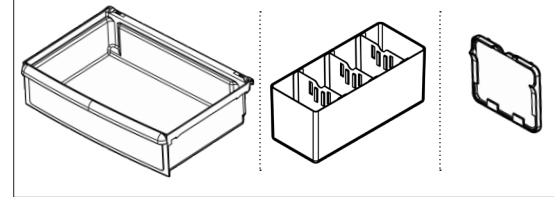

**Description**

One piece steel frame with epoxy painted finish available in 7 colours  
4 thermoplastic swivel castors, 2 with brakes, 125 mm Ø with non-marking rubber



Can be doubled if needed, without wasting space between cabinets

*Specific configurations*



Ref. PP-LOA400V1



Ref. PP-LOA600V1

**Logist'Alli**  
Tall mobile cabinet

Features		Ref. : MO-LOA600	
Construction	<b>One-piece frame</b>	Front section	<b>600</b>
Materials	<b>Steel</b>	75 drawer capacity	<b>20</b>
Available colours	<b>7</b>	50 basket capacity	<b>27</b>
Locking system	<b>Option</b>	MDDC capacity	<b>27</b>
Empty weight	<b>50kg</b>	P20 System No.	<b>81</b>

**Use:** The high cabinet makes possible vertical storage in limited spaces, optimising use of available space. The P20 system guarantees optimum organisation, allowing you to mix and match components by configuration and administrative procedures. The NoKey Concept uses a digicode touch keypad for access control, keeping costly or sensitive products completely secured (optional).

ALLIBERT MEDICAL S.A.S 9, Avenue des Trois Fontaines, CS 20503. 95015 Cergy-Pontoise CEDEX  
Tel.: +33 (0) 1 34 43 43 10. Tel.: +33 (0) 1 34 43 43 11 **Email: contact@allibert-medical.com**  
Items may differ from images - reproduction prohibited. Allibert Medical reserves the right to make changes to its products based on technological development.

The Preconfigured Range

# Logist'Alli Tall mobile cabinet

Ready to go

With 20 years of experience serving healthcare facilities, we have analysed and designed optimum configurations to meet your needs and expectations

Designed for space saving layouts.



Pharmacy cabinet F600	Réf.PP-LOA600V1
Configuration	
Electronic lock LS100	
Shelf	Level 1
Drawers 75	Level 2 to 10
Narcotic drawer 75	Level 11
Drawers 155	Level 12 to 16

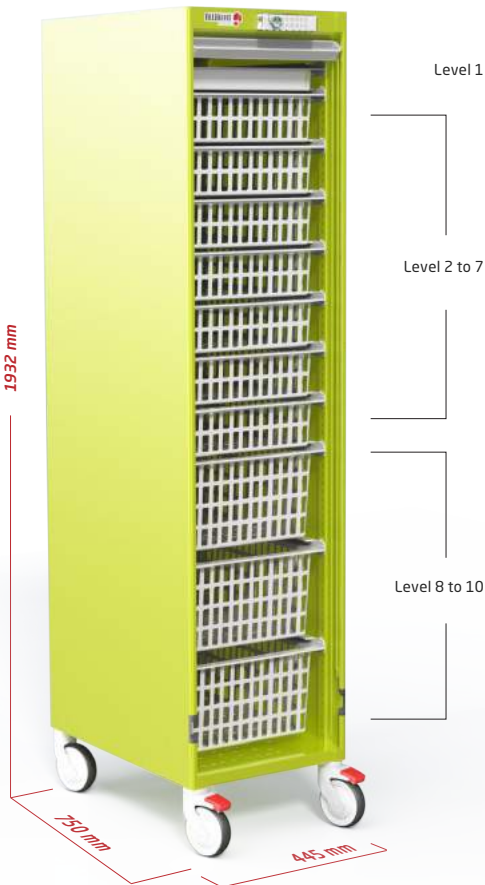

F400 Cabinet	Ref. PP-LOA400V1
Configuration	
Electronic lock LS100	
ABS basket tray 50 mm - solid	Level 1
ABS basket tray 100 mm - mesh	Level 2 to 7
ABS basket tray 200 mm - mesh	Level 8 to 10





Modular product



Options



2 roller wheels Ø 75  
ref. OP-M2110500  
2 roller wheels Ø 100  
ref. OP-M2110700

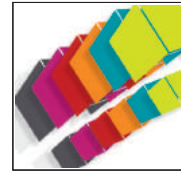

Colour range:  
7 colour choices  
(See Colour Information Sheet)

A wide range of components is available.  
(See components information sheet)

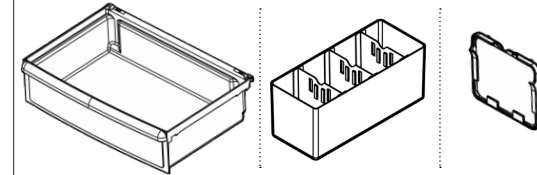

Description

One piece steel frame with epoxy painted finish available in 7 colours  
4 thermoplastic swivel castors, 2 with brakes, 125 mm Ø with non-marking rubber



Can be doubled if needed, without wasting space between units

Specific configurations



Ref. MO-MOR1421

Ref. PP-MOR1621V1

Mod'Alli  
Tall mobile cabinet

Features		Ref.: MO-MOR1621	
Construction	One-piece frame	Front section	600
Materials	Steel	75 drawer capacity	21
Available colours	7	50 basket capacity	28
Locking system	N/A	MDDC capacity	28
Empty weight	45kg	P20 System No.	84

**Use:** The high cabinet offers a large storage capacity and, thanks to the P20 system, the ability to integrate a variety of components to save even more space. Compact and sleek, it facilitates an optimum space saving layout in any room. Combined with drawers, the cabinet provides full protection against light and dust.

# Mod'Alli High cabinet

Ready to go

With 20 years of experience serving healthcare facilities, we have analysed and designed optimum configurations to meet your needs and expectations

The  
Preconfigured  
Range



Fluids storage cabinet F600	Ref.PP-MOR1621V1
Configuration	
Shelf	Level 1
Drawer 155 - with 30 compartments	Level 2 to 4
Drawer 155	Level 5 to 7
Drawer 235	Level 8 to 9

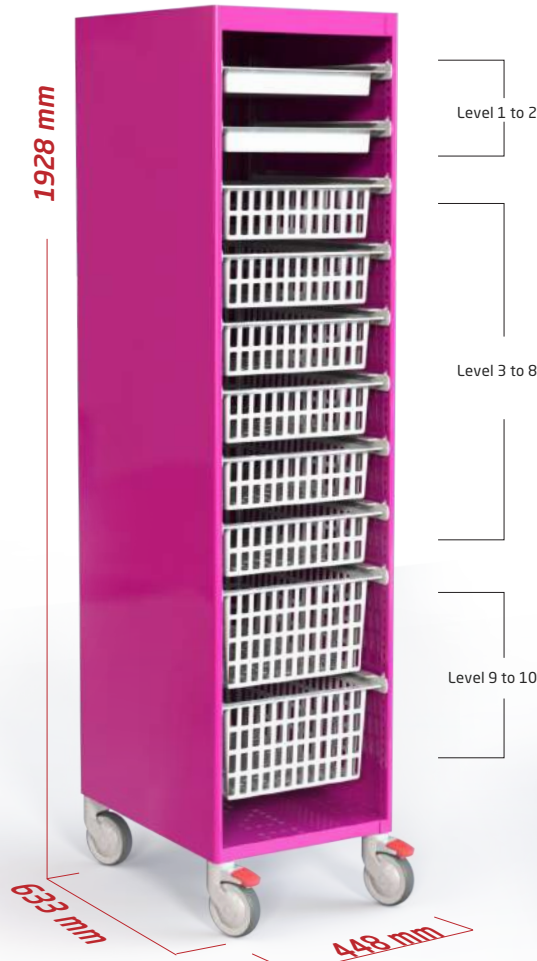

Storage cabinet F400	Ref.PP-MOR1421V1
Configuration	
ABS Basket height 50	Level 1 to 2
ABS Basket height 100	Level 3 to 8
ABS Basket height 200	Level 9 to 10

Can be doubled to save space between cabinets.







Modular products



Choice of Options



2 roller wheels Ø 75  
ref. OP-M2110500  
2 roller wheels Ø 100  
ref. OP-M2110700

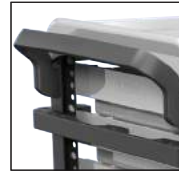

Offset handle on the additional side  
ref. OP-POIGNEE  
Front handles (x2)  
ref. OP-POIGFAC



Side rail (x4)  
ref. OP-RAIL



Back Covering:  
One colour:  
Volcanic black  
ref. OP-GUFONDNOIR

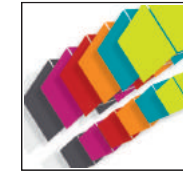

Colour range:  
7 colour choices  
(Extra option)  
(See Colour Information Sheet)

A wide range of components is available.  
(See components information sheet)

A wide variety of accessories is available.  
(See accessory information sheet)

Specific configurations



MO-LOC2x600



MO-LOC1200



MO-LOC400



MO-LOC2x400

Description

U-shape Construction for easy cleaning  
Colour: Volcanic black  
4 thermoplastic swivel castors, 2 with brakes,  
125 mm Ø with non-marking rubber  
Handle

Stock'Alli  
Delivery cart

Description		Ref. : MO-LOC600	
Construction	<b>Welded</b>	Front Panel	<b>600</b>
Materials	<b>Steel</b>	75 drawer capacity	<b>15</b>
Available colours	<b>7 choices</b>	50 basket capacity	<b>20</b>
Locking system	<b>N/A</b>	MDDC capacity	<b>21</b>
Empty weight	<b>27kg</b>	P20 System No.	<b>60</b>

**Use:** Designed for easy movement and quick re-supply process, this delivery cart optimises storage capacity with the P20 system. The EasyMov system reduces the physical effort needed in use, making it easy to manoeuvre, and ideal for transporting products between departments.

ALLIBERT MEDICAL S.A.S 9 rue des Trois Fontaines. CS 20503. 95015 Cergy-Pontoise Cedex  
Tel.: +33 (0) 1 34 43 43 10. Tel.: +33 (0) 1 34 43 43 11 **Email: contact@allibert-medical.com**

Items may differ from images - reproduction prohibited. Allibert Medical reserves the right to make changes to its products based on technological development.



# Stock'Alli Delivery cart

Ready to go

With 20 years of experience serving healthcare facilities, we have analysed and designed optimum configurations to meet your needs and expectations

The  
Preconfigured  
Range

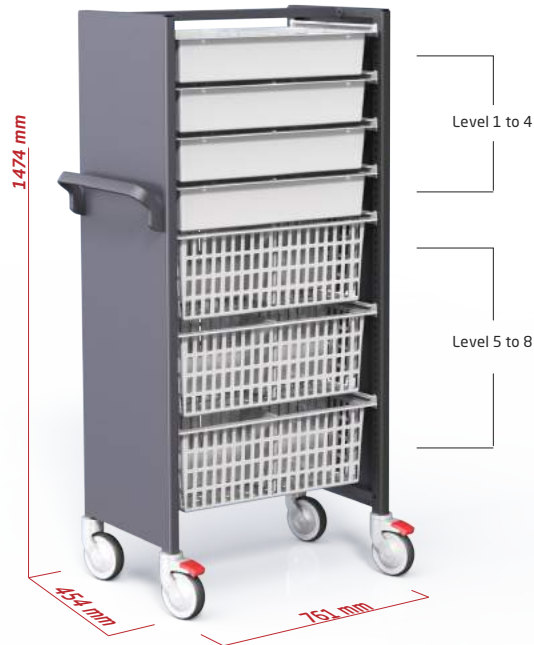

**Delivery cart with divider tray**

**Ref. PP-LOC600V1**

**Configuration**

Handle  
ABS basket tray 100 - solid  
ABS basket tray 200 - mesh

Levels 1 to 4  
Level 5 to 8



**Delivery cart with drawers**

**Ref. PP-LOC600V2**

**Configuration**

Handle  
Drawer 155 - with 4 compartments (4 trays)  
Drawer 235

Level 1 to 3  
Level 4 to 6

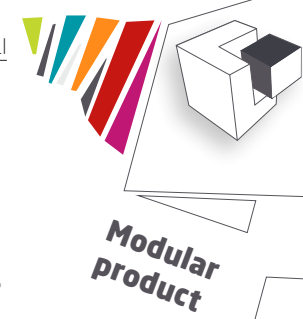

**Modular product**



**Options**

- 2 roller wheels Ø 75 ref. OP-M2110500  
2 roller wheels Ø 100 ref. OP-M2110700
- Offset handle on opposite side ref. OP-POIGNEE
- Offset handle on opposite side ref. OP-POIGNEE
- Back Cover: Single colour only: volcanic black ref. OP-GUFONDNOIR
- Colour range: 7 colour choices for side panels (Extra option) (See Colour Information Sheet)

**A wide range of components is available.**  
(See components information sheet)

**Description**

Steel frame, U section  
Volcanic black epoxy painted finish  
Side cover and reinforced back  
4 thermoplastic swivel castors, 2 with brakes,  
125 mm Ø with non-marking rubber



**Stock'Alli**  
Modular storage configuration

Features		Ref.: MO-LOR600	
Construction	<b>Welded</b>	Front panel	<b>600</b>
Materials	<b>Steel</b>	75 drawer capacity	<b>21</b>
Available colours	<b>7 choices</b>	50 basket capacity	<b>28</b>
Locking system	<b>N/A</b>	MDDC capacity	<b>29</b>
Empty weight	<b>31kg</b>	P20 System No.	<b>84</b>

**Use:** Specially designed for use in storage rooms and in-patient pharmacies, this cabinet guarantees optimal filling and space saving organisation thanks to the P20 system. The 400 column model fits in limited spaces and permits storage of specific smaller items. The 1200 column model allows larger packaged products to be stored. This range is equipped with outer panels in compliance with standards of good practice.

ALLIBERT MEDICAL S.A.S 9, Avenue des Trois Fontaines, CS 20503. 95015 Cergy-Pontoise CEDEX  
Tel.: +33 (0) 1 34 43 43 10. Tel.: +33 (0) 1 34 43 43 11 **Email: [contact@allibert-medical.com](mailto:contact@allibert-medical.com)**  
Items may differ from images - reproduction prohibited. Allibert Medical reserves the right to make changes to its products based on technological development.





## Stock'Alli

Modular storage  
configuration

Set-up

With 20 years of experience serving healthcare facilities, we have analysed and designed optimum configurations to meet your needs and expectations

**With the 400 or 600 single, double or triple column models, you can arrange your storage space in the best way possible**



### Storeroom layout

Configuration  
x4 LOR single F400  
x2 LOR Double F600

Ref. PP-LOC400V2  
Ref. PP-LOC600V2



Modular product

Choice of Options



2 roller wheels Ø 75  
ref. OP-M2110500  
2 roller wheels Ø 100  
ref. OP-M2110700



Offset handle  
ref. OP-POIGNEE



Offset handle on opposite side  
ref. OP-POIGNEE

A wide range of components is available.  
(See components information sheet)

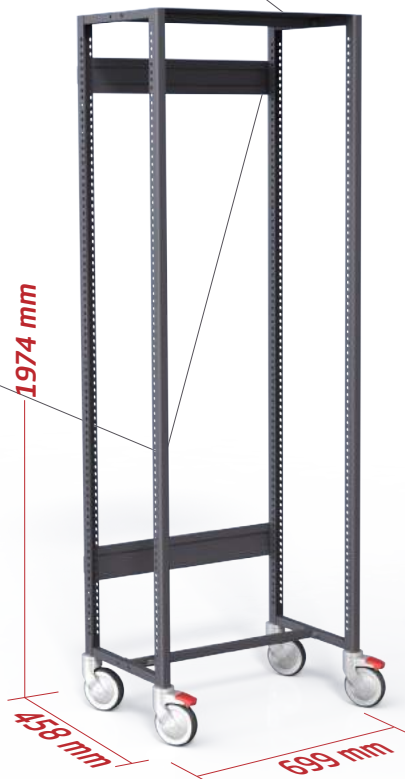

Ref. MO-RY2600R



Ref. MO-RY3600R



Ref. MO-RY1400R



Ref. MO-RY2400R



Ref. MO-RY3400R

Description

Steel frame, U section  
Volcanic black epoxy painted finish  
4 thermoplastic swivel castors, 2 with brakes,  
125 mm Ø with non-marking rubber

Stock'Alli  
Storage cabinet

Features		Ref.: MO-RY1600R	
Construction	<b>Welded</b>	Front Panel	<b>600</b>
Materials	<b>Steel</b>	75 drawer capacity	<b>21</b>
Available colours	<b>1</b>	50 basket capacity	<b>28</b>
Locking system	<b>N/A</b>	MDDC capacity	<b>29</b>
Empty weight	<b>20kg</b>	P20 System No.	<b>84</b>

**Use:** Specially intended for storage in storage rooms and in-patient pharmacies, this cabinet guarantees optimal filling and organisation thanks to the P20 system. The 400 column allows you to optimise your layout in limited spaces.

ALLIBERT MEDICAL S.A.S 9, Avenue des Trois Fontaines, CS 20503. 95015 Cergy-Pontoise CEDEX  
Tel.: +33 (0) 1 34 43 43 10. Tel.: +33 (0) 1 34 43 43 11 Email: [contact@allibert-medical.com](mailto:contact@allibert-medical.com)  
Items may differ from images - reproduction prohibited. Allibert Medical reserves the right to make changes to its products based on technological development.





# Stock'Alli Storage cabinet

Ready to go

With 20 years of experience serving healthcare facilities, we have analysed and designed optimum configurations to meet your needs and expectations

The  
Preconfigured  
Range

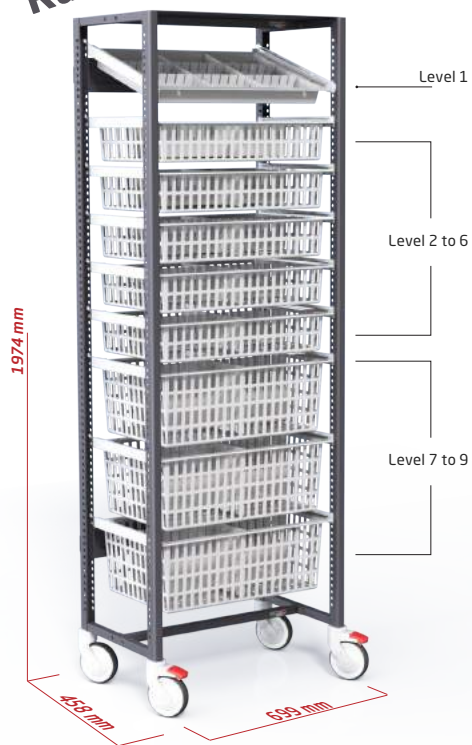

### Single column storage cabinet F600

Ref. PP-RY1600RV1

Configuration

Tilted ABS basket tray 50 - solid	Level 1
ABS basket tray 100 - mesh	Level 2 to 6
ABS basket tray 200 - mesh	Level 7 to 9



### Double storage cabinet F600 Ref. PP-RY2600RV1

Configuration

Tilted ABS basket tray 50 - solid	Level 1
ABS basket tray 100 - mesh	Level 2 to 6
ABS basket tray 200 - mesh	Level 7 to 9

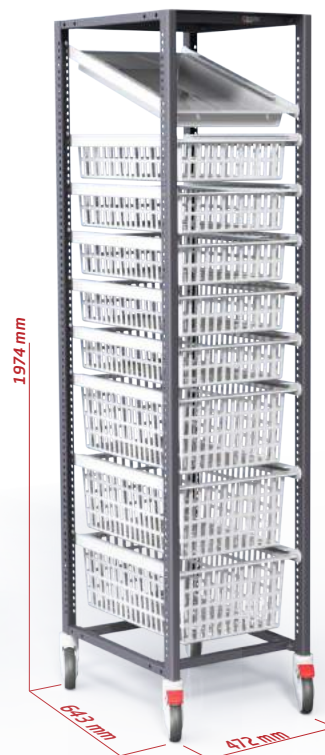

### Single column storage cabinet F400 Ref. PP-RY1400RV1

Configuration

Tilted ABS basket tray 50 - solid	Level 1
ABS basket tray 100 - mesh	Level 2 to 6
ABS basket tray 200 - mesh	Level 7 to 9

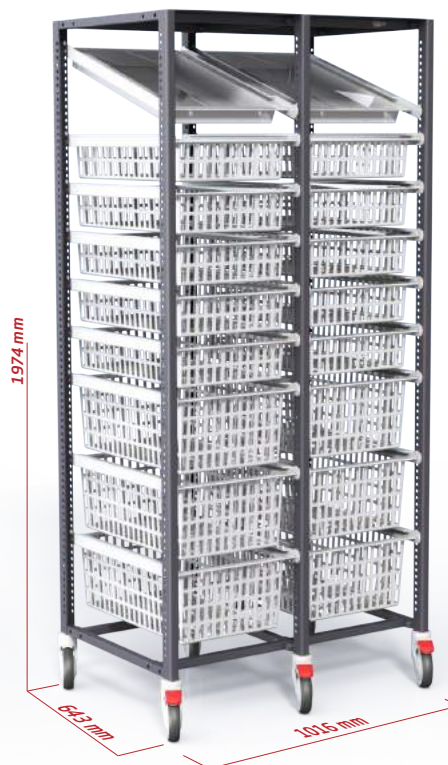

### Double storage cabinet F400 Ref. PP-RY2400RV1

Configuration

Tilted ABS basket tray 50 - solid	Level 1
ABS basket tray 100 - mesh	Level 2 to 6
ABS basket tray 200 - mesh	Level 7 to 9



Modular product

A wide range of components is available.  
(See components information sheet)

Specific configurations



**Description**

Steel frame, U section  
Volcanic black epoxy painted finish  
4 adjustable legs

**Stock'Alli**  
Storage cabinet

Features		Ref.: MO-RY1600K
Construction	<b>Kit assembly</b>	Front Panel F600
Materials	<b>Steel</b>	75 drawer capacity <b>21</b>
Available colours	<b>1</b>	50 basket capacity <b>28</b>
Locking system	<b>N/A</b>	MDDC capacity <b>29</b>
Empty weight	<b>19kg</b>	P20 System No. <b>84</b>

**Use:** Specially designed for use in storage facilities, storage rooms and OR pharmacies, this cabinet guarantees optimal filling and space-saving organisation thanks to the P20 system. The F400 single column cabinet allows you to optimise your layout in limited spaces.

# Stock'Alli Storage cabinet

Set-up

With 20 years of experience serving healthcare facilities, we have analysed and designed optimum configurations to meet your needs and expectations

## Optimal use of space



Layout example for a connected array of F400 Kit assembly storage cabinets





Modular product



**Options**



2 roller wheels Ø 75  
ref. OP-M2110500  
2 roller wheels Ø 100  
ref. OP-M2110700

**A wide range of components is available.**  
(See components information sheet)

**A wide variety of accessories is available.**  
(See accessory information sheet)

Specific configurations



Ref. PP-CHARNURV1



Ref. PP-CHARNURV2



Ref. PP-CHARNURV3

**Description**

Welded Construction and steel cover with epoxy painted finish, single colour, MDF tray 12mm thick with volcanic black painted finish, net volume 540mm x 800mm x120 mm  
4 thermoplastic swivel castors, 2 with brakes, 125 mm Ø with non-marking rubber

**Stock'Alli**  
Baby changing cart

Features		Ref.: MO-CHARNUR	
Construction	<b>Welded</b>	Front section	<b>600</b>
Materials	<b>Steel</b>	75 drawer capacity	<b>9</b>
Available colours	<b>1</b>	50 basket capacity	<b>12</b>
Locking system	<b>N/A</b>	MDDC capacity	<b>12</b>
Empty weight	<b>30kg</b>	P20 System No.	<b>36</b>

**Use:** Compact and adjustable, the baby changing cart puts everything you need for the baby within easy reach. Its EasyMov system means that it can be moved easily while floors are cleaned. Wheels are equipped with brakes to ensure full stability. The EasyClean design makes it easy to disinfect the cart.

ALLIBERT MEDICAL S.A.S 9, Avenue des Trois Fontaines, CS 20503. 95015 Cergy-Pontoise CEDEX  
Tel.: +33 (0) 1 34 43 43 10. Tel.: +33 (0) 1 34 43 43 11 **Email: [contact@allibert-medical.com](mailto:contact@allibert-medical.com)**  
Items may differ from images - reproduction prohibited. Allibert Medical reserves the right to make changes to its products based on technological development.





# Stock'Alli Baby changing cart

Ready to go

With 20 years of experience serving healthcare facilities, we have analysed and designed optimum configurations to meet your needs and expectations

The  
Preconfigured  
Range



**Baby changing cart V1**

Ref.: PP-CHARLANV1

Configuration	
Baby changing table, protective raised sides 125 mm	Level 1
Standard shelf	Level 2
Standard shelf	Level 3

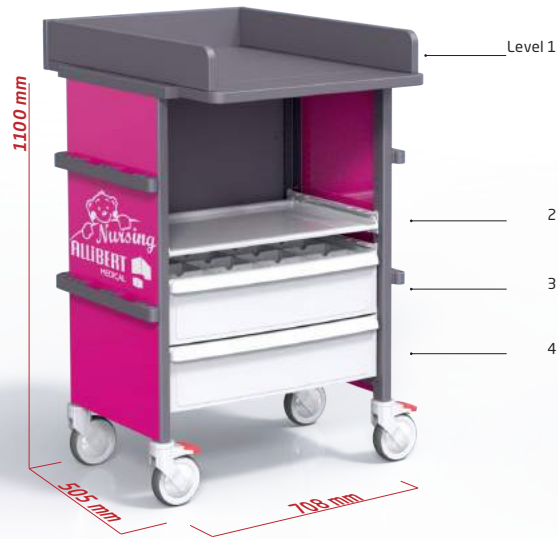

**Baby changing cart V2**

Ref.: PP-CHARLANV2

Configuration	
Baby changing table, protective raised sides 125 mm	Level 1
Standard shelf	Level 2
Drawer 155	Level 3
Drawer 155	Level 4



**Baby changing cart V3**

Ref.: PP-CHARLANV3

Configuration	
Baby changing table, protective raised sides 125 mm	Level 1
Drawer 75 - with 30 compartments	Level 2
Drawer 75 - with 20 compartments	Level 3
Drawer 155 - with 18 compartments	Level 4
Drawer 155 - with 12 compartments	Level 5
Drawer 235 - without compartments	Level 6



Modular product



**Options**



2 roller wheels Ø 75  
ref. OP-M2110500  
2 roller wheels Ø 100  
ref. OP-M2110700

**A wide range of components is available.**  
(See components information sheet)

**A wide variety of accessories is available.**  
(See accessory information sheet)



**Special accessories**



AC-M77927



AC-M77928

Specific configuration: Tall mobile isolation cart



PP-M270814HV1

MO-M270814

**Description**

Tubular steel construction with volcanic block epoxy painted finish  
4 thermoplastic swivel castors, 2 with brakes, 125 mm Ø with non-marking rubber

**Layout**

High and low mobile rails

Features		Ref. : MO-M270814H	
Construction	<b>Welded</b>	Frame	<b>Low and high</b>
Materials	<b>Steel</b>	75 drawer capacity	<b>2</b>
Available colours	<b>1</b>	50 basket capacity	<b>N/A</b>
Locking system	<b>N/A</b>	MDDC capacity	<b>N/A</b>
Empty weight	<b>14.5kg</b>	P20 System No.	<b>N/A</b>

**Use:** Intended for treatment purposes, particularly in isolation rooms, this cart can be easily disinfected thanks to its EasyClean design. Its modular design enables it to be accessorised in the best way and adapt to different work methods.

# ALLIBERT

MEDICAL



For an organised, secure, ergonomic and environmentally friendly medical treatment area.



Modular product



**Options**



2 roller wheels Ø 75  
ref. OP-M2110500  
2 roller wheels Ø 100  
ref. OP-M2110700

A wide range of components is available.  
(See components information sheet)

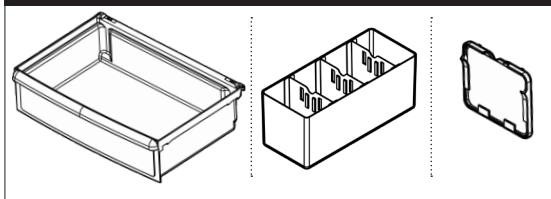

Dedicated accessories



Specific configurations



MO-M21074R (smaller) with steering handle  
845 mm

**Description**

Tubular steel construction with component-attachment rack, volcanic black epoxy painted finish, 4 thermoplastic swivel castors, 2 with brakes, 125 mm Ø with non-marking rubber

**Layout**

Pharmacy picking stations

Features		Ref. : MO-M21074	
Construction	<b>Welded</b>	Frame	<b>long and short</b>
Materials	<b>Steel</b>	Rails capacity	<b>10</b>
Available colours	<b>1</b>	50 basket capacity	<b>N/A</b>
Locking system	<b>N/A</b>	MDDC capacity	<b>N/A</b>
Empty weight	<b>18kg</b>	P20 System No.	<b>N/A</b>

**Use:** Designed to make product selection easy for pharmacy staff, within the medication process the picking station can be specially adapted to the volume of items stocked. A work surface or drawer unit can be attached to this model. The low picking station makes it possible to stock items in limited spaces and makes transport easier.



## Layout Pharmacy picking stations

Set-up

Use multiple picking stations to create organised picking areas.

## Pharmacy layout

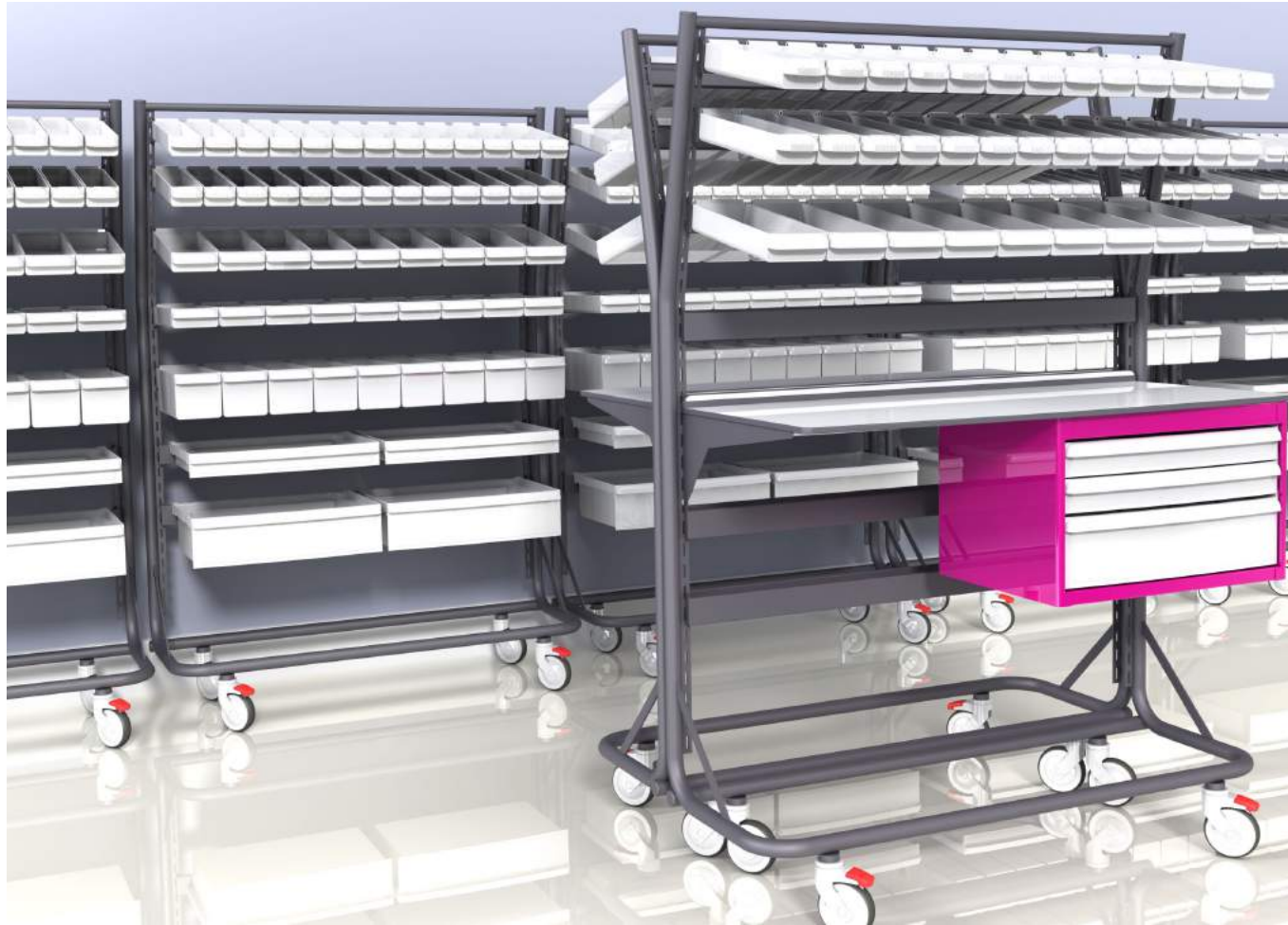

Suggestion for picking station area layout



### Description

Tubular steel construction with volcanic black epoxy painted finish  
 4 thermoplastic swivel castors, 2 with brakes, 125 mm Ø with non-marking rubber

## Layout Mobile workstation

### Features Ref. : MO-M21076

Construction	<b>Welded</b>	Frame	<b>N/A</b>
Materials	<b>Steel</b>	75 drawer capacity	<i>Depending on option</i>
Available colours	<b>1</b>	50 basket capacity	<i>Depending on option</i>
Locking system	<b>N/A</b>	MDDC capacity	<i>Depending on option</i>
Empty weight	<b>18kg</b>	P20 System No.	<i>Depending on option</i>

**Use:** The workstation has sleek design features which allow easy integration into any work space layout. The desk is available with or without drawers. Incorporating the EasyClean solution, it is easy to disinfect.

ALLIBERT MEDICAL S.A.S 9, Avenue des Trois Fontaines, CS 20503. 95015 Cergy-Pontoise CEDEX  
 Tel.: +33 (0) 1 34 43 43 10. Tel.: +33 (0) 1 34 43 43 11 **Email: [contact@allibert-medical.com](mailto:contact@allibert-medical.com)**  
 Items may differ from images - reproduction prohibited. Allibert Medical reserves the right to make changes to its products based on technological development.

### 410-MOBILE WORKSTATION -LAYOUT

#### Options



2 roller wheels Ø 75  
 ref. OP-M2110500  
 2 roller wheels Ø 100  
 ref. OP-M2110700

#### Drawer unit options 3 drawers

MO-MSR6004G



MO-M21076 + MO-MSR6004G

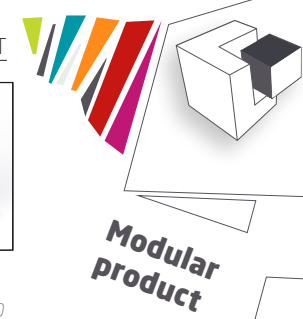

**Modular product**

# ALLIBERT

MEDICAL



For an organised, secure, ergonomic and environmentally friendly medical treatment area.





**Modular product**



### Options



2 roller wheels Ø 75  
ref. OP-M2110500  
2 roller wheels Ø 100  
ref. OP-M2110700



Digicode keypad lock:  
ref. OP-LS100 (no card)  
ref. OP-LS200 (with card)  
(See Locking System Information Sheet)



Colour range:  
7 colour choices  
(See Colour Information Sheet)

**A wide range of components is available.**  
(See components information sheet)

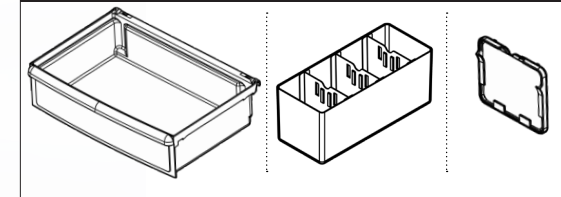

### Specific configurations

Under counter drawer unit F600  
8 drawer tracks



Ref. MO-MOR6008G

### Description

H75mm drawer capacity (9 drawers)  
One-piece aluminium frame  
Epoxy painted finish available in 7 colours  
Resin enamel top tray  
4 thermoplastic swivel castors, 2 with brakes,  
125 mm Ø with non-marking rubber

## Layout Mod'Alli drawers

Features		Ref.: MO-MOR6008G	
Construction	One-piece frame	Front section	600
Materials	Aluminium	75 drawer capacity	9
Available colours	7	50 basket capacity	12
Locking system	Option	MDDC capacity	12
Empty weight	19kg	P20 System No.	36

**Use:** This mobile drawer unit can be used as a work surface or for under-workstation storage, and is available in several heights, with or without a locking system. The P20 system is integrated into the unit, permitting efficient space-saving organisation. With its aluminium frame, the drawer storage unit is extremely lightweight and easy to move. The EasyClean system enables easy and effective decontamination.

ALLIBERT MEDICAL S.A.S 9, Avenue des Trois Fontaines, CS 20503. 95015 Cergy-Pontoise CEDEX  
Tel.: +33 (0) 1 34 43 43 10. Tel.: +33 (0) 1 34 43 43 11 **Email: [contact@allibert-medical.com](mailto:contact@allibert-medical.com)**  
Items may differ from images - reproduction prohibited. Allibert Medical reserves the right to make changes to its products based on technological development.

## Layout Mod'Alli drawers

Set-up

Easily combined, work surfaces and drawer units ensure harmonious and effective configuration in treatment rooms. The EasyMov system facilitates easy movement of the units so that floors can be disinfected.

### Combination fixed and mobile working area



Mod'Alli layout suggestion



**Modular product**

## Options



2 roller wheels Ø 75  
ref. OP-M2110500  
2 roller wheels Ø 100  
ref. OP-M2110700



Digicode keypad lock:  
ref. OP-LS100 (no card)  
ref. OP-LS200 (with card)  
(See Locking System Information Sheet)

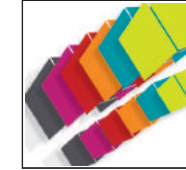

Colour range:  
7 colour choices  
(See Colour Information Sheet)

**A wide range of components is available.**  
(See components information sheet)

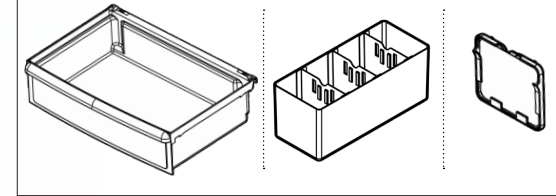

*Specific configurations*

*Under counter drawer unit F600  
7 drawer tracks*



Ref. MO-LOA6007G



## Description

Capacity 9 drawers H around 75 mm  
One-piece aluminium frame with epoxy painted finish available in 7 colours  
Resin-enamel top tray  
4 thermoplastic swivel castors, 2 with brakes,  
125 mm Ø with non-marking rubber  
Polypropylene (PP) roller shutter and digicode keypad LS100

## Layout

### Logist'Alli drawers unit

Features		Ref. : MO-LOA6009G	
Construction	<b>One-piece frame</b>	Front section	<b>600</b>
Materials	<b>Aluminium</b>	75 drawer capacity	<b>9</b>
Available colours	<b>7</b>	50 basket capacity	<b>12</b>
Locking system	<b>Option</b>	MDDC capacity	<b>12</b>
Empty weight	<b>vkg</b>	P20 System No.	<b>36</b>

**Use:** This mobile drawer unit can be used as a work surface or for under-counter storage, and is available in several heights, with or without a locking system. The P20 system is integrated into the unit, permitting efficient space-saving organisation. With an aluminium frame, our drawer units are extremely lightweight and easily movable. The EasyClean system enables easy and effective disinfection.

ALLIBERT MEDICAL S.A.S 9, Avenue des Trois Fontaines, CS 20503. 95015 Cergy-Pontoise CEDEX  
Tel.: +33 (0) 1 34 43 43 10. Tel.: +33 (0) 1 34 43 43 11 **Email: [contact@allibert-medical.com](mailto:contact@allibert-medical.com)**  
Items may differ from images - reproduction prohibited. Allibert Medical reserves the right to make changes to its products based on technological development.



**Layout**  
Logist'Alli drawer unit  
Set-up

Easily combined, work surfaces and drawer units ensure harmonious and effective configuration in treatment rooms. The EasyMov system facilitates easy movement of the units so that floors can be disinfected.

## Combination fixed and mobile working area



Logist'Alli layout suggestion



**Modular product**



**Options**

- 2 roller wheels Ø 75  
Ref. OP-M2110500  
2 roller wheels Ø 100  
Ref. OP-M2110700
- Digicode keypad lock:  
Ref. OP-LS100 (no card)  
Ref. OP-LS200 (with card)  
(See Locking System Information Sheet)
- Overbridge:  
Ref. M21122XX
- Bracket:  
Ref. M21061XX
- Colour range:  
7 colour choices  
(See Colour Information Sheet)

**A wide range of components is available.**  
(See components information sheet)

**A wide variety of accessories is available.**  
(See accessory information sheet)

Specific configurations



F600 Ref. MO-MOR26009 + work surface option

F600 Ref. MO-MOR36009G

**Description**

One-piece aluminium frame  
Epoxy painted finish available in 7 colours  
Resin-enamel top tray  
4 thermoplastic swivel castors, 2 with brakes,  
125 mm Ø with non-marking rubber  
Empty weight: **38 kg**

**Layout**

Mod'Alli mobile work surfaces

Features		Ref. : MO-MOR26009G	
Construction	One-piece frame	Façade	Double 600
Materials	Aluminium	75 drawer capacity	9 per unit
Available colours	7	50 basket capacity	12 per unit
Locking system	Option	MDDC capacity	12 per unit
Empty weight	38Kg	P20 System No.	36 per unit

**Use:** Intended for storage in nurse rooms, the mobile, double and triple work surface range ensures optimal storage. The set-up of the work surfaces is adapted to the configuration of the areas and the specific nature of the treatment. With an aluminium frame, our drawer units are extremely lightweight and easily movable. The EasyClean system enables easy and effective disinfection.

ALLIBERT MEDICAL S.A.S 9, Avenue des Trois Fontaines, CS 20503. 95015 Cergy-Pontoise CEDEX  
Tel.: +33 (0) 1 34 43 43 10. Tel.: +33 (0) 1 34 43 43 11 **Email: contact@allibert-medical.com**  
Items may differ from images - reproduction prohibited. Allibert Medical reserves the right to make changes to its products based on technological development.



**Drawer unit**  
Mobile work surfaces

Set-up

Easily combined, work surfaces and drawer units ensure harmonious and effective configuration in treatment rooms. The EasyMov system facilitates easy movement of the units so that floors can be disinfected.

**Combination fixed and mobile working area**



Mod'Alli layout suggestion



**Modular product**



**Options**

- 2 roller wheels Ø 75  
Ref. OP-M2110500  
2 roller wheels Ø 100  
Ref. OP-M2110700
- Digicode keypad lock:  
Ref. OP-LS100 (no card)  
Ref. OP-LS200 (with card)  
(See Locking System Information Sheet)
- Overbridge:  
Ref. M21122XX
- Bracket:  
Ref. M21061XX
- Colour range:  
7 colour choices  
(See Colour Information Sheet)

**A wide range of components is available.**  
(See components information sheet)

**A wide variety of accessories is available.**  
(See accessory information sheet)

*Specific configurations*



F600 Ref. MO-LOR26009G + work surface optional

F600 Ref. MO-LOR36009G

**Description**

One-piece aluminium frame with epoxy painted finish available in 7 colours  
Resin-enamel top tray with splashback  
4 thermoplastic swivel castors, 2 with brakes,  
125 mm Ø with non-marking rubber  
Polypropylene (PP) roller shutter and digicode keypad LS100  
Empty weight: 46 kg

**Layout**

Logist'Alli mobile work surfaces

Features		Ref. : MO-LOR26009G	
Construction	<b>One-piece frame</b>	Front cover	<b>Double 600</b>
Materials	<b>Aluminium</b>	75 drawer capacity	<b>9 per unit</b>
Available colours	<b>7</b>	50 basket capacity	<b>12 per unit</b>
Locking system	<b>Option</b>	MDDC capacity	<b>12 per unit</b>
Empty weight	<b>38Kg</b>	P20 System No.	<b>36 per unit</b>

**Use:** Intended for storage in nurse rooms, the mobile, double and triple work surface range ensures optimal storage and work surfaces adapted to the layout of department facilities and the specific nature of the treatment.  
With an aluminium frame, our drawer units are extremely lightweight and easy to move. The EasyClean system enables easy and effective disinfection.

ALLIBERT MEDICAL S.A.S 9, Avenue des Trois Fontaines, CS 20503. 95015 Cergy-Pontoise CEDEX  
Tel.: +33 (0) 1 34 43 43 10. Tel.: +33 (0) 1 34 43 43 11 **Email: [contact@allibert-medical.com](mailto:contact@allibert-medical.com)**  
Items may differ from images - reproduction prohibited. Allibert Medical reserves the right to make changes to its products based on technological development.



## Layout

Logist'Alli mobile work surfaces

Set-up

Combination mobile work surfaces and carts to create integrated work stations.

## Island and Logist'Alli Cart



Logist'Alli layout example





Modular product



**Drawer unit options**  
4 drawer-tracks  
MO-MSR6004G

**Options**

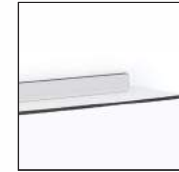

Bracket:  
Ref. M21061XX

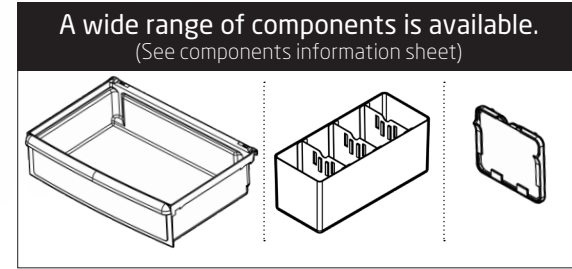

A wide range of components is available.  
(See components information sheet)

Specific configurations



Ref. MO-M21012

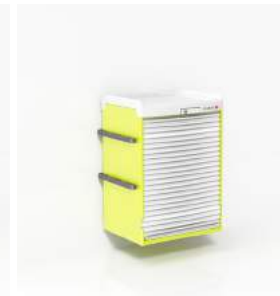

Ref. MO-M21011



Ref. MO-M21010

**Description**

End fixture at rear to secure standard rail.  
Resin-enamel top tray thickness 13 mm  
Optional: Suspended drawer unit

**Layout**

Hanging work surfaces

Features		Ref. : MO-M2106 XX	
Construction	Aluminium	Length	0.7m to 2m
Tray	Trespa laminate	75 drawer capacity	(according to option selected)
Available colours	7	50 basket capacity	(according to option selected)
Locking system	N/A	MDDC capacity	(according to option selected)
Empty weight	12-13kg	P20 System No.	(according to option selected)

**Use:** The hanging work surface range allows washing of floors without having to move the units. The work surface can be complemented by a drawer unit or replaced by suspended cabinets and carts.

ALLIBERT MEDICAL S.A.S 9, Avenue des Trois Fontaines, CS 20503. 95015 Cergy-Pontoise  
CEDEX  
Tel.: +33 (0) 1 34 43 43 10. Tel.: +33 (0) 1 34 43 43 11 Email: [contact@allibert-medical.com](mailto:contact@allibert-medical.com)

Items may differ from images - reproduction prohibited. Allibert Medical reserves the right to make changes to its products based on technological development.



## Layout

Hanging work surfaces

### Alternative configuration

There are work surface mix and match options available. Choose a 600 front section, compartments with or without a roller shutters and holding capacity for 4 or 8 drawer tracks.

1

#### Work surface options



#### Work surface dimensions

Length 0.70m to 2m  
Depth 0.55m or 0.80m

#### Bracket option



2

#### Closure options



#### Connected drawers

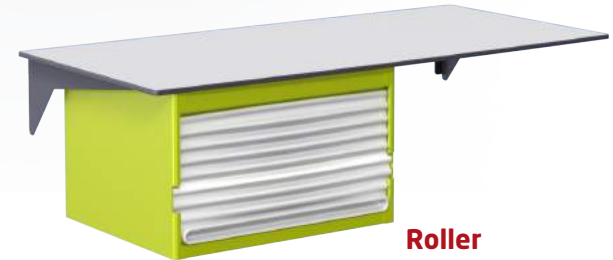

#### Roller shutter

3

#### Capacity options



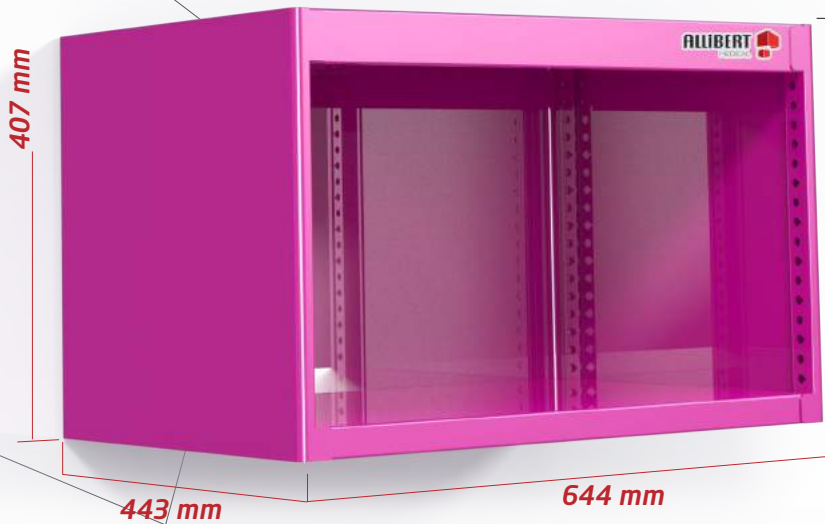

#### 401-HANGING UNITS -LAYOUT

#### Options

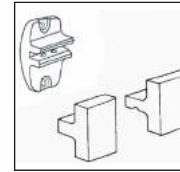

Fixture kit  
Option included  
OP-M21059



Digicode keypad lock:  
ref. OP-LS100 (no card)  
ref. OP-LS200 (with card)  
(See Locking System  
Information Sheet)

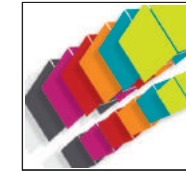

Colour range:  
7 colour choices  
(See Colour  
Information Sheet)



**Modular  
product**

**A wide range of components is available.**  
(See components information sheet)

Joined cupboards

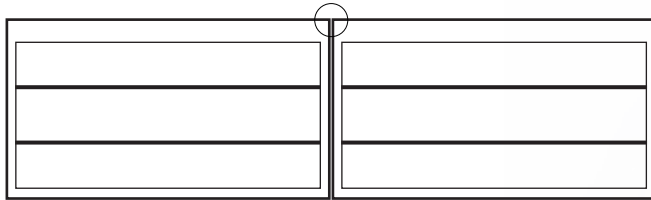

Specific configurations



With shelf Ref. MO-MSR6004G



With drawers Ref. MO-MSR6004G



With roller shutter Ref. MO-M21059

### Description

One-piece aluminium frame  
Epoxy painted finish available in 7 colours

### Layout

## Wall-mounted cupboard

Features		Ref.: MO-MSR6004G	
Construction	<b>One-piece frame</b>	Front section	<b>600</b>
Materials	<b>Aluminium</b>	75 drawer capacity	<b>4</b>
Available colours	<b>7</b>	50 basket capacity	<b>5</b>
Locking system	<b>Optional</b>	MDDC capacity	<b>5</b>
Empty weight	<b>10kg</b>	P20 System No.	<b>16</b>

**Use:** Smart and practical, wall mounted cupboards provide ample functional storage for disposables and pharmaceutical products. This model is also available with a lockable roller shutter.

ALLIBERT MEDICAL S.A.S 9, Avenue des Trois Fontaines, CS 20503. 95015 Cergy-Pontoise CEDEX  
Tel.: +33 (0) 1 34 43 43 10. Tel.: +33 (0) 1 34 43 43 11 **Email: [contact@allibert-medical.com](mailto:contact@allibert-medical.com)**  
Items may differ from images - reproduction prohibited. Allibert Medical reserves the right to make changes to its products based on technological development.



## Layout Wall-mounted cupboard

Layout

Easily combined, wall-mounted cupboards, work surfaces and drawer units ensure an optimal layout in work rooms. The EasyMov system facilitates easy movement of the units so that floors can be disinfected.



Wall-mounted cupboard



Modular product



**Options**



Wheel options:  
 2 fixed wheels and 1 brake  
 Ref. APXX01  
 2 fixed wheels and a central brake  
 Ref. APXX02  
 4 swivel wheels, directional blocking system and centralised brake Ref. APXX03



Coupling Option:  
 Ref. OP-APO

A wide range of components is available.  
 (See components information sheet)

Specific configurations



Ref. AP601



Ref. AP401



Ref. AP2401



Ref. AP3401

**Description**

Aluminium construction  
 Cabinet with anti-torsion system  
 Two hinged doors with 270° opening and magnet stoppers in open position  
 Non-marking rubber bumpers at the base and top.

**Supply**  
 Supply trolley

Features		Ref. : AP2601	
Construction	<b>Kit assembly</b>	Front section	<b>Double column 600</b>
Materials	<b>Aluminium</b>	Height	<b>1787</b>
Available colours	<b>1</b>	75 drawer capacity	<b>32</b>
Locking system	<b>Optional</b>	50 basket capacity	<b>42</b>
Empty weight	<b>87kg</b>	P20 System No.	<b>128</b>

**Use:** Manually operated or motorised, supply carts can fully meet the logistical needs of health care organisations and their suppliers, and also provide secure storage for pharmaceutical products. Its design and construction materials make it suitable for heavy duty use, and it can be cleaned in a tunnel washer.

ALLIBERT MEDICAL S.A.S 9, Avenue des Trois Fontaines, CS 20503. 95015 Cergy-Pontoise CEDEX  
 Tel.: +33 (0) 1 34 43 43 10. Tel.: +33 (0) 1 34 43 43 11 **Email: contact@allibert-medical.com**  
 Items may differ from images - reproduction prohibited. Allibert Medical reserves the right to make changes to its products based on technological development.



# ALLIBERT

MEDICAL



For an organised, secure, ergonomic and environmentally friendly medical treatment area.

ALLIBERT MEDICAL S.A.S 9, Avenue des Trois Fontaines, CS 20503. 95015 Cergy-Pontoise CEDEX  
Tel.: +33 (0) 1 34 43 43 10. Tel.: +33 (0) 1 34 43 43 11 **Email: [contact@allibert-medical.com](mailto:contact@allibert-medical.com)**  
Items may differ from images - reproduction prohibited. Allibert Medical reserves the right to make changes to its products based on technological development.



**Modular product**

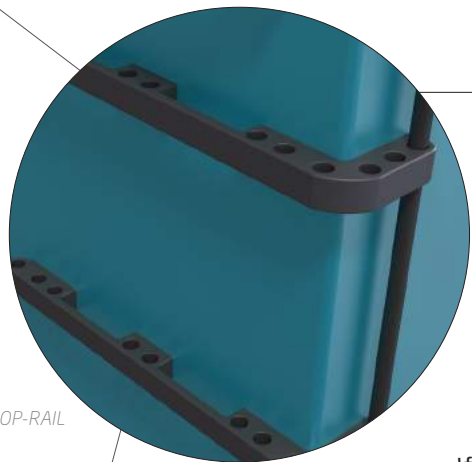

Ref. OP-RAIL

Printer stand QL220



Ref. AC-M77949

Laptop arm



Ref. AC-M77897SZ

Monitoring support

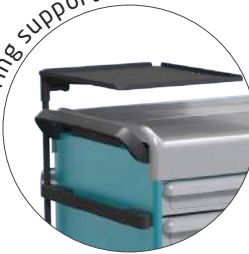

Ref. AC-M21093SC

Coupling System



Ref. AC-M21088MA

Serum holder



Ref. AC-M21039SI

Foldable writing shelf

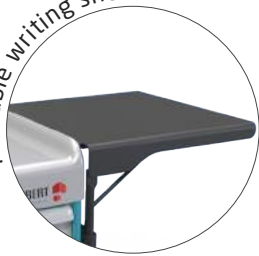

Ref. AC-M21029MC

Oxygen cylinder holder



Ref. AC-M21038SI

File holder



Ref. AC-M21036SC

Hanging file container



Ref. AC-M1809011A

Cardiac (CPR) board



Ref.AC-M77871 (infants)  
Ref.AC-M21049SZ (adults)

Flange accessory with hook

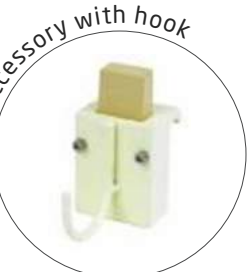

Ref. AC-M77892

Overall hook flange accessory



Ref. AC-M77929

Waste management: Strap x 2

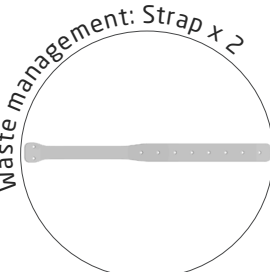

Ref. AC-M21027SA

Seals (50)



Ref. AC-D7910101

Adhesive magnetic strip

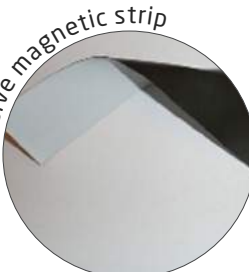

Ref. AC-M77942

Catheter container with 4 compartments



Ref. AC-M21025SC

## Accessories

### Features

No tools needed for assembly	yes
Multi-position	yes
Easy-Clip rail	yes
Available colours	Volcanic black
EasyClean	yes

**Use:** You can now attach and configure a wide range of accessories to meet your individual specifications or according to the functions assigned to the cart or cabinet. Attached to the EasyClip rail, your work surface is 100% available for use whenever you need it.

## Accessories

# Accessories

Use: You can now attach and configure a wide range of accessories to meet your individual specifications or according to the functions assigned to the cart or cabinet. Attached to the EasyClip rail, your work surface is 100% available for use whenever you need it.



Ref. AC-M21025SC (cart)  
Ref. AC-M21025SCSTO (trolley)



Ref. AC-M21033SC (cart)  
Ref. AC-M21033SCSTO (trolley)



Ref. AC-M2103301 (cart)  
Ref. AC-M2103301STO (trolley)



Ref. AC-M21031SC

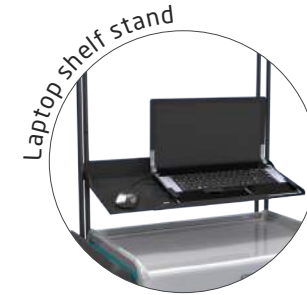

Ref. AC-M21031INF (cart)  
Ref. AC-M21031INFSTO (trolley)

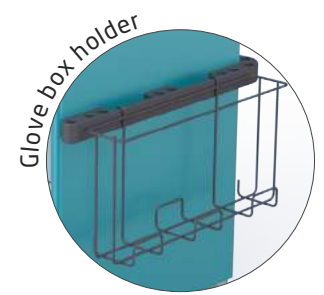

Ref. AC-BOGAN

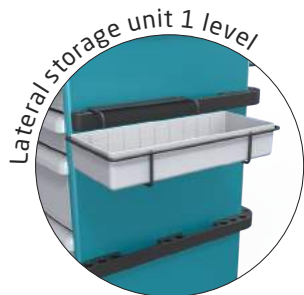

Ref. AC-M21020SC

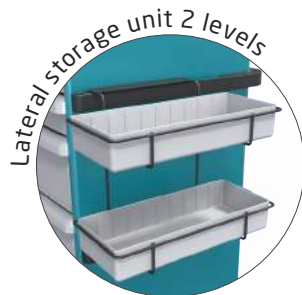

Ref. AC-M21021SC



Ref. AC-M21037SC (cart)  
Ref. AC-M21037SCSTO (trolley)



Ref. AC-M77883  
(6 boxes)



Ref. AC-M77882  
(5 boxes)

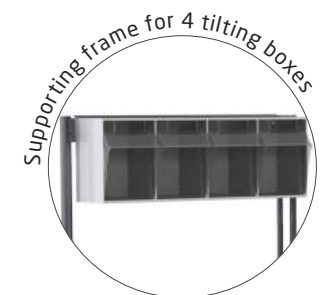

Ref. AC-MM77881  
(4 boxes)



Ref. AC-M21063SI



Ref. AC-M21066SI



Ref. AC-M21028SC



Ref. AC-M77869



Ref. AC-M21027NV



Ref. AC-M77926



## ABS basket tray height options

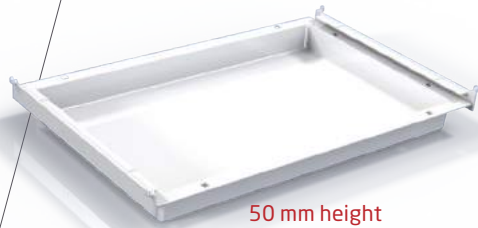

50 mm height  
Ref. CO-BAL50PT

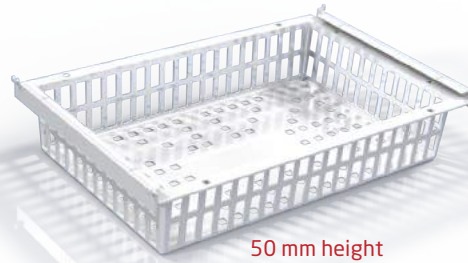

50 mm height  
Ref. CO-BAL100AT



200 mm height  
Ref. CO-BAL200AT

510-DIVIDER TRAY



Modular product

## ABS basket tray with separators

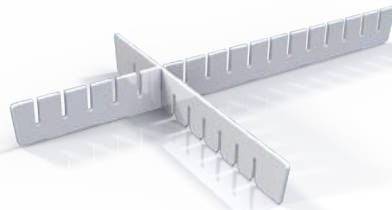

H50mm separators  
long Ref. CO-PL50PT  
short Ref. CO-PC50PT

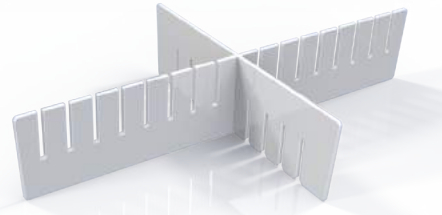

H100mm separators  
long Ref. CO-PL100PT  
short Ref. CO-PC100PT

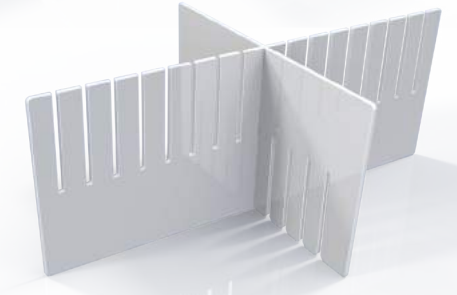

H200mm separators  
long Ref. CO-PL200PT  
short Ref. CO-PC200PT

### Dedicated components



Clip for divider tray separators  
Ref. CO-CTP

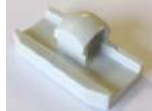

Safety stop  
Ref. CO-BA



Vertical label holder  
Ref. CO-M24534VB



Divider tray label holder  
Ref. CO-M77816VB



Universal horizontal label holder  
Ref. CO-M77816



Universal vertical label holder  
Ref. CO-M77816V

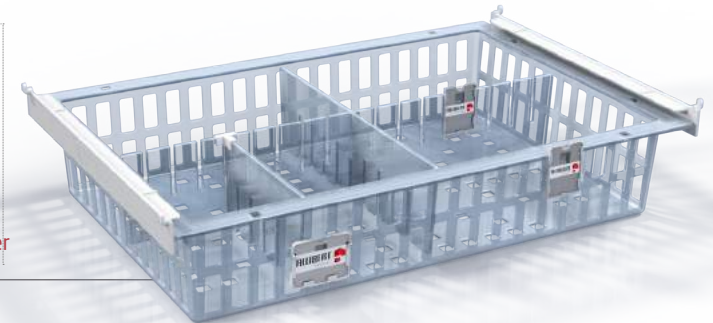

## Component Divider tray

### Features

Includes	Tray, without handle
Separator type	Divisible separators
Labelling	Front and interior (dedicated)
Materials	Transparent ABS
Standard	ISO 3394, 2012 version

**Use:** Particularly suitable for storage units, the ABS basket tray has a simple partitioning system using separators which make it easy to create different size compartments. The heights available permit their use for storage of a wide variety of items (liquids, medical devices, disposables, etc.).

ALLIBERT MEDICAL S.A.S 9, Avenue des Trois Fontaines, CS 20503. 95015 Cergy-Pontoise CEDEX  
Tel.: +33 (0) 1 34 43 43 10. Tel.: +33 (0) 1 34 43 43 11 Email: [contact@allibert-medical.com](mailto:contact@allibert-medical.com)  
Items may differ from images - reproduction prohibited. Allibert Medical reserves the right to make changes to its products based on technological development.

## Component Divider tray

Short and long separators allow you to partition divider trays depending on package size and inventory volume.

**Short separator  
(across)**

**Safety stop**

**Long separator  
(down)**

**Clips for divider  
tray separators**

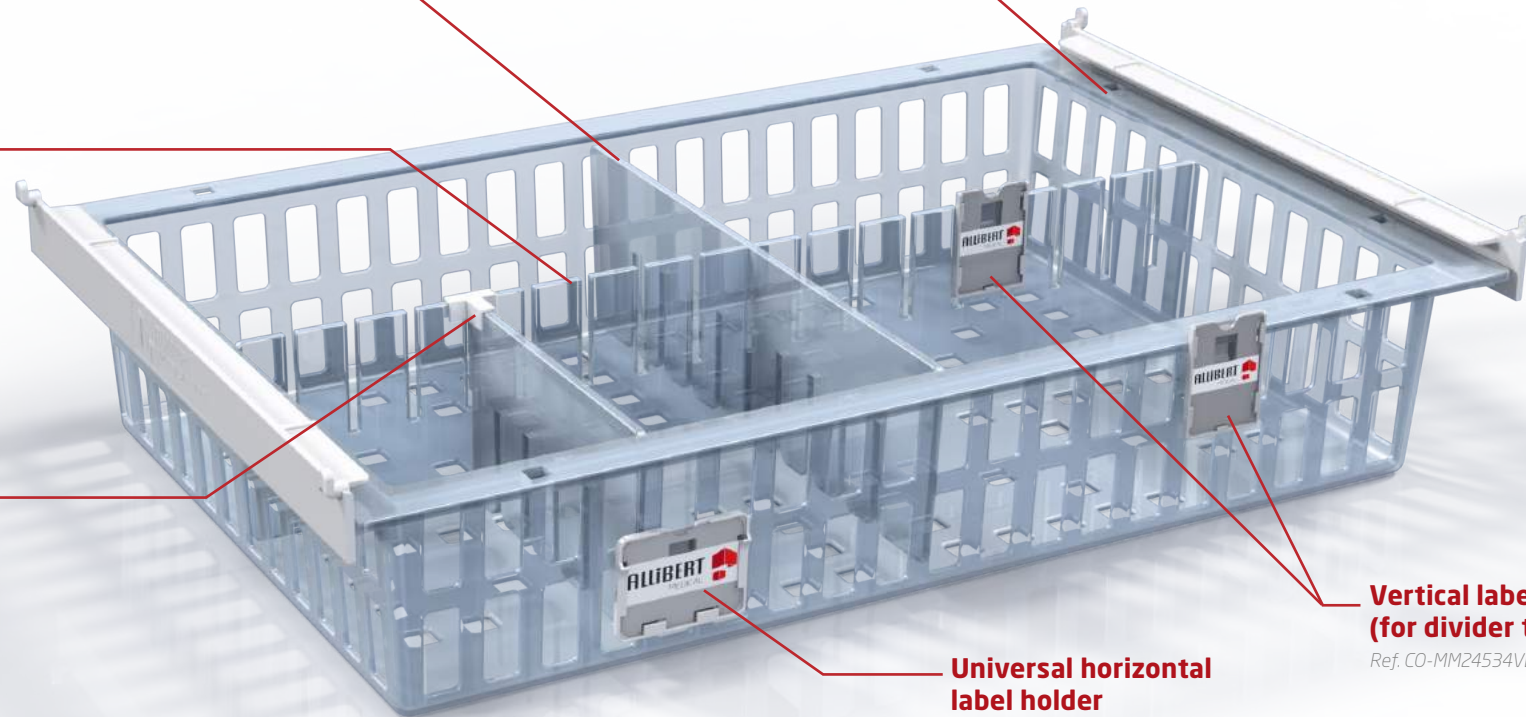

**Universal horizontal  
label holder**

Ref. CO-M77816

**Vertical label holder  
(for divider trays)**

Ref. CO-MM24534VB



**Modular product**

## Drawer height options



**Height 75mm**  
Ref. CO-M24502MC



**Height 155mm**  
Ref. CO-M24503MC



**Height 235mm**  
Ref. AC-M24504MC

## Partitioning: Drawer dividers



**1/6 H75**  
Ref. CO-M24509MC



**1/4 H75**  
Ref. CO-M24510MC

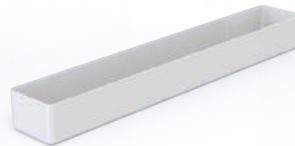

**1/4 H75 Long**  
Ref. CO-M24512MC



**1/6 H155**  
Ref. CO-M24523MC



**1/4 H155**  
Ref. CO-M24511MC



**1/4 H155 Long**  
Ref. CO-M24522MC

## Partitioning: Separators



**1/6 H75**  
Ref. CO-M24513MC



**1/4 H75**  
Ref. CO-M24514MC

Dedicated components



**1/6 H155**  
Ref. CO-M24525MC



**1/4 H155**  
Ref. CO-M24515MC



**Label holder for drawer (attachment)** 1/2 Ref. CO-M77815  
Attachment 1/4 Ref. CO-M24611MZ  
Attachment 1/6 Ref. CO-M24610MZ



**Card label holder**  
1 slot Ref. CO-M77905  
2 slots Ref. CO-M77906  
3 slots Ref. CO-M77906



**Universal horizontal label holder**  
Ref. CO-M77816



**Universal vertical label holder**  
Ref. CO-M77816V



## Component Drawers F600

### Features

Includes	<b>Tray with integrated handle</b>
Separator type	<b>Individual tray and mobile separator</b>
Labelling	<b>Front and interior</b>
Materials	<b>White polypropylene</b>
Standard	<b>ISO 3394, 2012 version</b>

**Use:** The drawer system is adapted to the full range of units. Compartmentalisation options permit to separate, secure, store individual products of individual products. The compartment size can be adapted according to the dimensions of specific pharmaceutical packages, liquid containers or bottles, consumables, etc.

ALLIBERT MEDICAL S.A.S 9, Avenue des Trois Fontaines, CS 20503. 95015 Cergy-Pontoise CEDEX  
Tel.: +33 (0) 1 34 43 43 10. Tel.: +33 (0) 1 34 43 43 11 **Email: [contact@allibert-medical.com](mailto:contact@allibert-medical.com)**  
Items may differ from images - reproduction prohibited. Allibert Medical reserves the right to make changes to its products based on technological development.

## Component Drawers F600

With endless ways to divide them, the drawer system allows you to configure compartmentalisation to fit the dimensions of specific pharmaceutical packages, liquid containers etc.

The  
Preconfigured  
Range

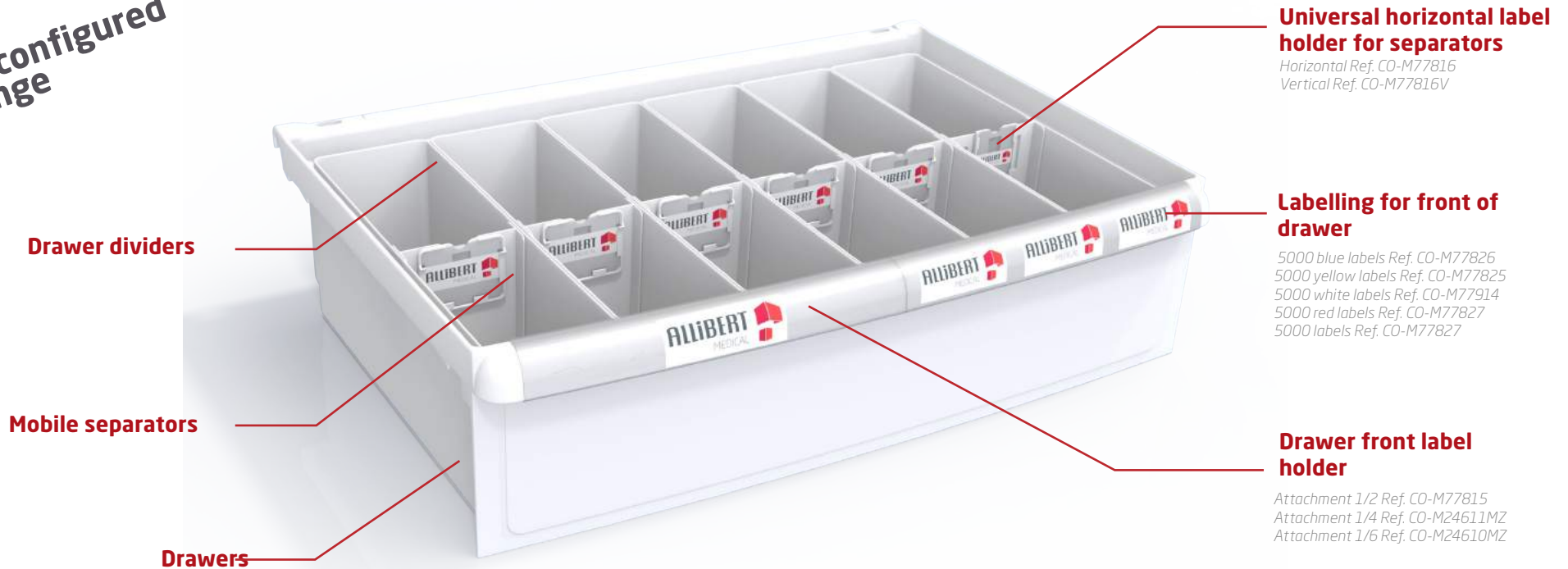

Special drawers



**Narcotics drawer H 75 mm**  
Ref. CO-M21045MC



**Narcotics drawer H 155 mm**  
Ref. CO-M21046MC



**Narcotics drawer H 235 mm**  
Ref. CO-M21047MC



**Hanging file drawer**  
Ref. CO-M21022MC

## Standard shelf

508-SHELF



Modular  
product



**Divider Bim system**



**Files shelves with 14 spaces**

Ref. CO-M77899



**Catheter holder shelf**

Ref. CO-M24505MP



**Wall shelf**

Ref. CO-M24527SC

## Component Shelf

### Features

Construction	Shelf
Separator type	N/A
Labelling	N/A
Materials	Reinforced ABS glass fibre

**Use:** The shelf completes the range of components, offering an alternative open organising system. It can also act as a catheter holder, file holder or wall mounted shelf.

ALLIBERT MEDICAL S.A.S 9, Avenue des Trois Fontaines, CS 20503. 95015 Cergy-Pontoise CEDEX  
Tel.: +33 (0) 1 34 43 43 10. Tel.: +33 (0) 1 34 43 43 11 Email: [contact@allibert-medical.com](mailto:contact@allibert-medical.com)  
Items may differ from images - reproduction prohibited. Allibert Medical reserves the right to make changes to its products based on technological development.

**ALLIBERT**  
MEDICAL

# ALLIBERT

MEDICAL



For an organised, secure, ergonomic and environmentally friendly medical treatment area.

ALLIBERT MEDICAL S.A.S 9, Avenue des Trois Fontaines, CS 20503. 95015 Cergy-Pontoise CEDEX  
Tel.: +33 (0) 1 34 43 43 10. Tel.: +33 (0) 1 34 43 43 11 **Email: [contact@allibert-medical.com](mailto:contact@allibert-medical.com)**  
Items may differ from images - reproduction prohibited. Allibert Medical reserves the right to make changes to its products based on technological development.



## Drawers dividers Bin



6 compartments h75 mm



Ref. CO-M24506MC

4 compartments h75 mm



Ref. CO-M24507MC

4 compartments h155 mm



Ref. CO-M24508MC

2 compartments h75 mm



Ref. CO-M77888

2 compartments h155 mm



Ref. CO-M77889

**Modular product**

## Compartment system: Separators

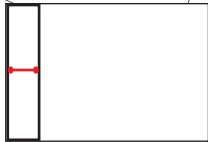

H 75mm 1/6



Ref. CO-M24513MC

H 75mm 1/4



Ref. CO-M24514MC

H 155mm 1/4



Ref. CO-M24515MC

## Labelling



**Label holder for drawer (attachment) 1/2 Ref. CO-M77815**  
Attachment 1/4 Ref. CO-M24611MZ  
Attachment 1/6 Ref. CO-M24610MZ



MO-M21074



MO-M21074R

**Example of drawer dividers for a dispensary**

**Example of drawer dividers for a standard shelf**



## Component Drawer dividers

### Features

Attachment	Shelf or rail
Separator type	Mobile separator
Labelling	Front and interior
Materials	White polypropylene

**Use:** For use on wall rails and at picking stations, drawer dividers bins make organisation and product selection easy in hospital pharmacies and treatment rooms. They can also be adapted to fit standard shelves, for daily medication solution.

# ALLIBERT

MEDICAL



For an organised, secure, ergonomic and environmentally friendly medical treatment area.

ALLIBERT MEDICAL S.A.S 9, Avenue des Trois Fontaines, CS 20503. 95015 Cergy-Pontoise CEDEX  
Tel.: +33 (0) 1 34 43 43 10. Tel.: +33 (0) 1 34 43 43 11 **Email: [contact@allibert-medical.com](mailto:contact@allibert-medical.com)**  
Items may differ from images - reproduction prohibited. Allibert Medical reserves the right to make changes to its products based on technological development.





## Daily pillbox tray:

2 heights available

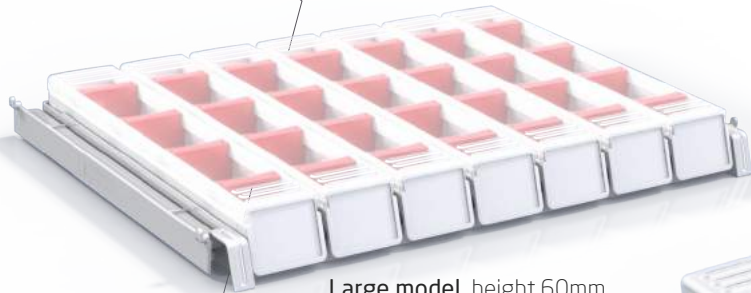

Large model height 60mm  
Ref. CO-MEC70002

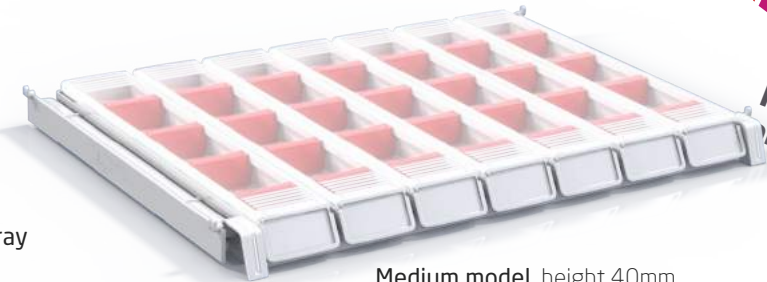

Medium model height 40mm  
Ref. CO-MEC70001

Modular  
product

### Transparent daily pillbox tray

Ref. CO-MEC70012 (large)  
Ref. CO-MEC70011 (small)

Sliding lid

Tray with handle  
and label holder

4 mobile separators per daily  
pillbox tray

Ref. CO-MEC70009 (large model separator)  
Ref. CO-MEC70008 (small model separator)

Daily pillbox tray label holder

Ref. CO-MEC80021 (large model separator)  
Ref. CO-MEC80020 (medium model separator)

White label for daily pillbox tray

Réf. CO-MEZ80021 (large model label)  
Réf. CO-MEZ80020 (medium model label)

## Dedicated components



White label



Label holder



Opening system  
Ref. CO-SOBI

## Component

### 7 daily pillboxes tray set

#### Features

Construction	Pillbox tray
Separator type	Daily pillbox tray
Labelling	Special
Pillbox tray material	Transparent polypropylene

**Use:** The daily pillbox tray set facilitates daily and weekly medication. Available as a transparent tray so that the contents are clearly visible. It can be easily adapted to individual patient needs. Sliding separators and two heights are available.

ALLIBERT MEDICAL S.A.S 9 rue des Trois Fontaines, CS 20503, 95015 Cergy-Pontoise Cedex  
Tel.: +33 (0) 1 34 43 43 10. Tel.: +33 (0) 1 34 43 43 11 Email: [contact@alibert-medical.com](mailto:contact@alibert-medical.com)  
Items may differ from images - reproduction prohibited. Allibert Medical reserves the right to make changes to its products based on technological development.

## Component

7 medium daily pillboxes tray set

With 20 years of experience serving healthcare facilities, we have analysed and designed optimum configurations to meet your needs and expectations



**7 medium size daily pillboxes tray set**

*Ref. CO-MEC70001*

**2 large size daily pillboxes tray set**

*Ref. CO-MEC70002*





**Modular  
product**

**1-level cassette:** For patient bin of height 120 mm



**With door**  
Ref. CO-M24623MS

**Patient bin with handle**

Height 75 Length 1/6: Ref. AC-M24509 MP  
Height 75 Length 1/4: Ref. AC-M24510 MP  
Height 120 Length 1/6: Ref. AC-M24523 MP  
Height 120 Length 1/6 smooth v: Ref. AC-M24523 MPL

**2-level cassette:** For patient bin of height 75 mm



**With door**  
Ref. CO-M24623MC



**No door**  
Ref. CO-M24622MC

**(Handle option)**



**3-level cassette:** For patient bins with a height of 75 mm



**With door**  
Ref. CO-M24626MC



**No door**  
Ref. CO-M24625MC

**(Handle option)**



## Component Cassette

### Features

Construction	<b>Cassettes 3 heights / lockable</b>
Separator type	<b>trays with handle</b>
Labelling	<b>handle and divider</b>
Materials	<b>ABS</b>

**Use:** Designed for dispensing by name, cassettes enables storage and transport of named patient bins between the pharmacy (whether centralised or otherwise) and the ward.

# ALLIBERT

MEDICAL



For an organised, secure, ergonomic and environmentally friendly medical treatment area.

ALLIBERT MEDICAL S.A.S 9, Avenue des Trois Fontaines, CS 20503. 95015 Cergy-Pontoise CEDEX  
Tel.: +33 (0) 1 34 43 43 10. Tel.: +33 (0) 1 34 43 43 11 **Email: [contact@allibert-medical.com](mailto:contact@allibert-medical.com)**  
Items may differ from images - reproduction prohibited. Allibert Medical reserves the right to make changes to its products based on technological development.



**Modular product**

**Level 1: LS 100**  
 Digicode keypad option, without card access



**Level 2: LS 200**  
 Access control with digicode keypads and user ID cards

**Electronic user ID card:**  
 Opens lock when swiped across keypad

**Programming card:**  
 Allows locks to be programmed easily and monitors opening of cabinets



Access control with digicode keypads

**Level 3: LS 400**  
 Access control with digicode keypads and user ID cards with full traceability

**Electronic user ID card:**  
 Allows department administrator access when card is swiped across keypad

**Programming card:**  
 Allows locks to be programmed easily and monitors opening of cabinets

**Staff ID card**  
 Allows staff access when swiped across keypad

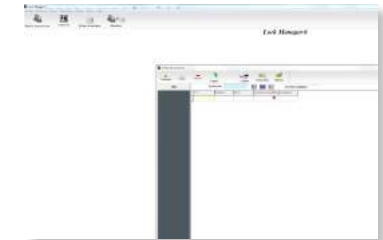

- Access control with digicode keypads and ID cards  
 - Monitors opening of cabinets

**Options**

Digicode keypad and electronic ID card

Features	
Security	Keypad and card
Locking system	Central
Keypad colour	White
Battery life	3 years (based on 30 openings per day)
Access to battery without disabling locking system	yes

**Use:** The intelligent electronic lock system provides greater access control for the units, with three levels of security and elimination of a "physical" key. It also ensures better monitoring of pharmaceutical inventory and dispensing.

# ALLIBERT

MEDICAL



For an organised, secure, ergonomic and environmentally friendly medical treatment area.

ALLIBERT MEDICAL S.A.S 9, Avenue des Trois Fontaines, CS 20503. 95015 Cergy-Pontoise CEDEX  
Tel.: +33 (0) 1 34 43 43 10. Tel.: +33 (0) 1 34 43 43 11 **Email: [contact@allibert-medical.com](mailto:contact@allibert-medical.com)**  
Items may differ from images - reproduction prohibited. Allibert Medical reserves the right to make changes to its products based on technological development.



Modular product

**Hypnotic** Fushia



Ref. OP-FH

**Banana** Yellow



Ref. OP-JB

**Curaçao** Blue



Ref. OP-BC

**Nirvana** Green



Ref. OP-VN

**Fusion** Red



Ref. OP-RF

**Sparkling** White



Ref. OP-BP

**Volcanic** black



Ref. OP-NV

**Cart identification (in option)**

Department, number, establishment name



Cart/Trolley/Cabinet identification options  
ref. OP-ID

## Options Colours

**Use:** Choose from our exclusive range of colours. You can assign a separate colour to each department or medical specialty, in harmony with interior design requirements or preferences. Allibert Médical offers a complementary labelling service that allows you customise your carts and cabinets with the markings or logos of your choice.

# ALLIBERT

MEDICAL



For an organised, secure, ergonomic and environmentally friendly medical treatment area.

ALLIBERT MEDICAL S.A.S 9, Avenue des Trois Fontaines, CS 20503. 95015 Cergy-Pontoise CEDEX  
Tel.: +33 (0) 1 34 43 43 10. Tel.: +33 (0) 1 34 43 43 11 **Email: [contact@allibert-medical.com](mailto:contact@allibert-medical.com)**  
Items may differ from images - reproduction prohibited. Allibert Medical reserves the right to make changes to its products based on technological development.





*Simple and intuitive*



EasyClip® design frees up and optimises work surface availability. You can attach and adapt the many Allibert Medical accessories depending on where and how the cart or cabinet is to be used.

*Flexible equipment components*

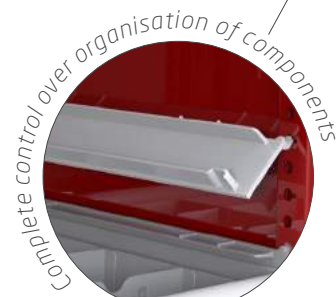

With the P20® system, there is optimal use of space and restocking is very simple and precise (under 2cm). The drawer tracks can be unhooked to make cleaning easier (for soaking/ dishwasher). Drawer track without fixtures, 1 for each side.

*All parts are easily accessible*



The result of research into effective disinfection, Allibert Medical's EasyClean® solution ensures simple dismantling to allow complete disinfection of all components and surfaces, for fast through cleaning.

*Minimal physical effort required for use*

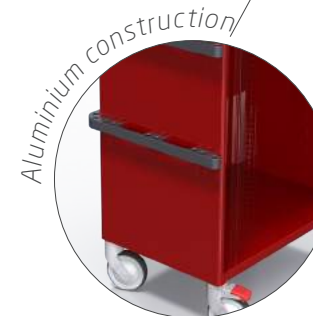

Allibert Médical incorporates lightweight, ultra-resistant, high-performance materials in its ergonomic design process, in order to ensure optimal comfort and ease of use.

*Intelligent locking*



With its touch keypad locking system, Allibert Medical also makes it possible to monitor access to cabinets, thus ensuring fully controlled dispensing of pharmaceutical drugs and narcotic substances.

**Design Concepts**

**Use:** Based on its extensive experience, Allibert Médical has designed its new range to meet your specific needs. By actively listening to our clients, combined with our use of the latest technology, we have been able to identify five major areas for innovation in order to anticipate your needs.

# ALLIBERT

MEDICAL



For an organised, secure, ergonomic and environmentally friendly medical treatment area.

ALLIBERT MEDICAL S.A.S 9, Avenue des Trois Fontaines, CS 20503. 95015 Cergy-Pontoise CEDEX  
Tel.: +33 (0) 1 34 43 43 10. Tel.: +33 (0) 1 34 43 43 11 **Email: [contact@allibert-medical.com](mailto:contact@allibert-medical.com)**  
Items may differ from images - reproduction prohibited. Allibert Medical reserves the right to make changes to its products based on technological development.



# Summary

## Mod'Alli Construction (in mm)

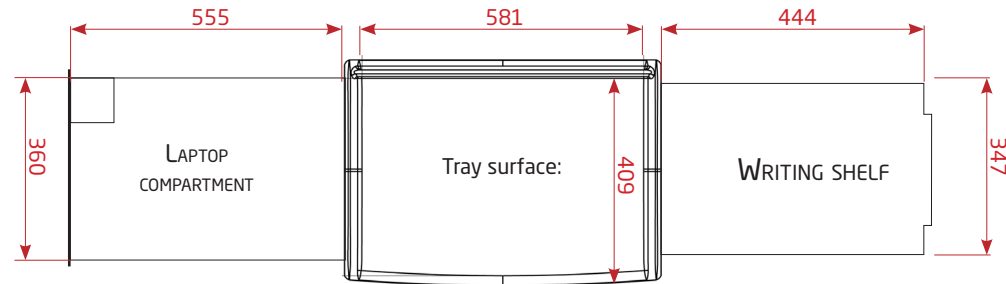

Mod'Alli 9G

Mod'Alli 9G + CTSP0

Mod'ALLI 12G

Mod'Alli 15G

Mod'Alli 18G

Mod'Alli F600 21G

Mod'ALLI F400 21G

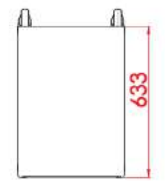
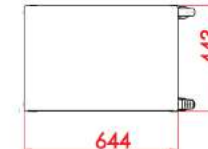
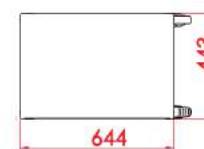
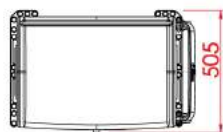
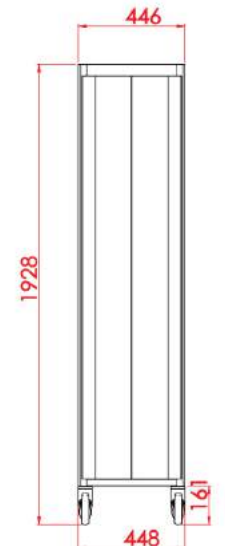
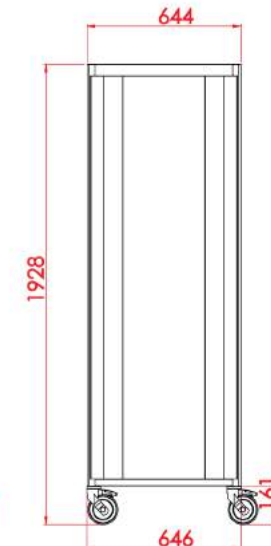
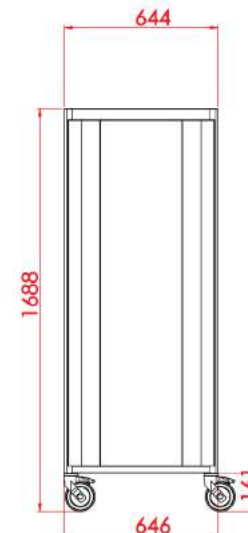
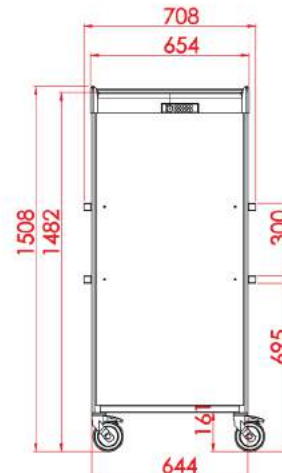
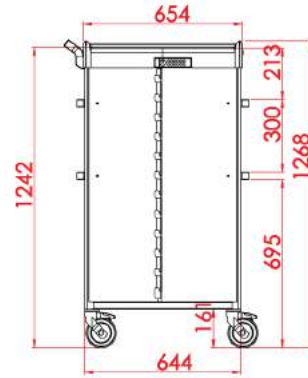
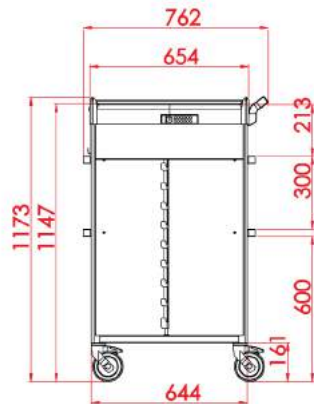
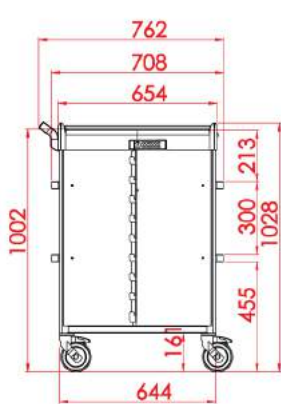

# Summary

## Logist'Alli Construction (in mm)

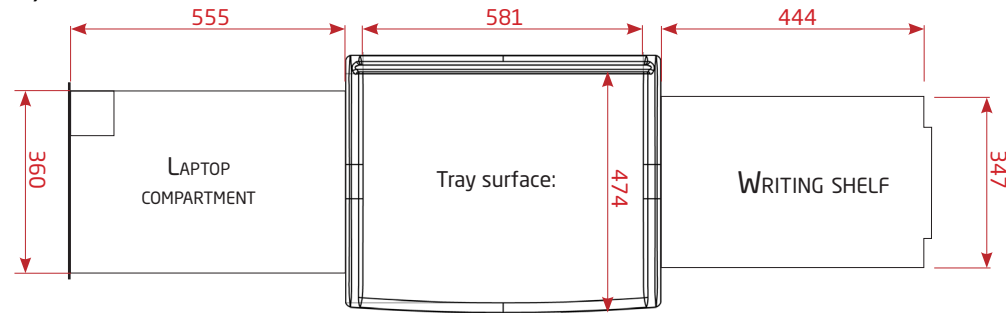

Logist'Alli 9G

Logist'ALLI 9G +CTSP0

Logist'Alli 10G + CTSP0

Logist'Alli 15G

Logist'Alli F600 18G

Logist'ALLI F600 18G Motorisée

Logist'Alli F600 20G

Logist'Alli F400 20G

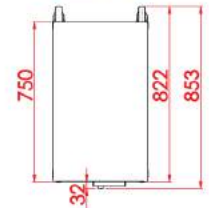
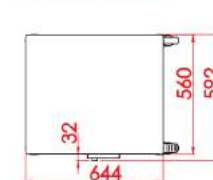
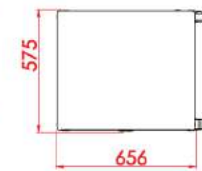
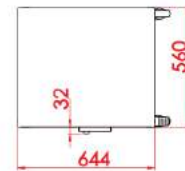
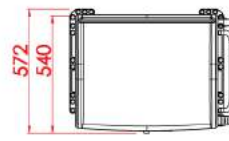
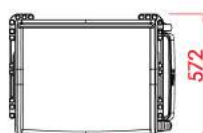
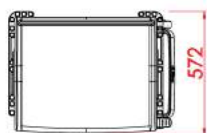
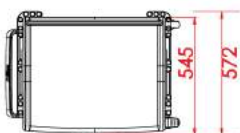
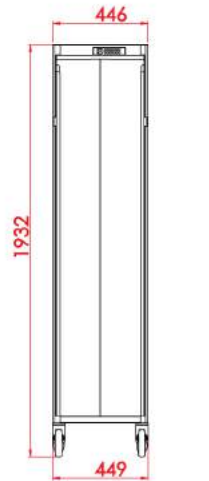
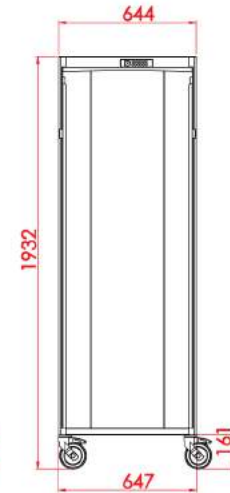
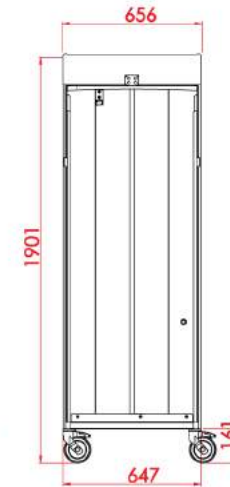
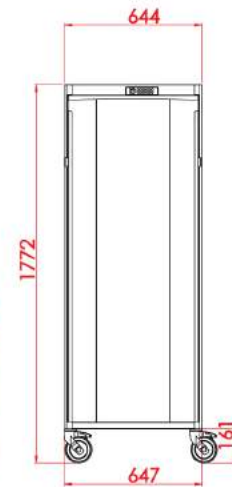
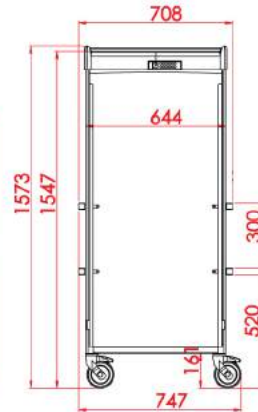
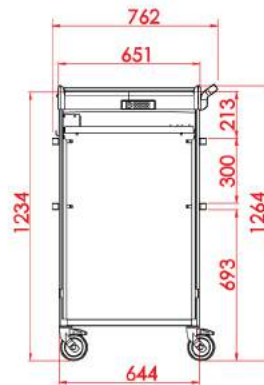
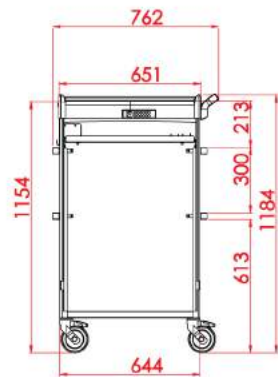
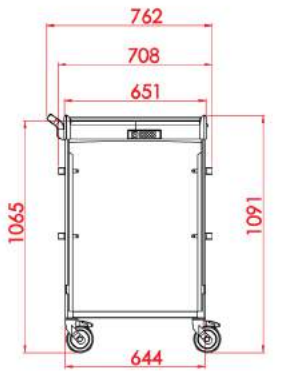



# Summary

## Stock'Ali Construction (in mm)

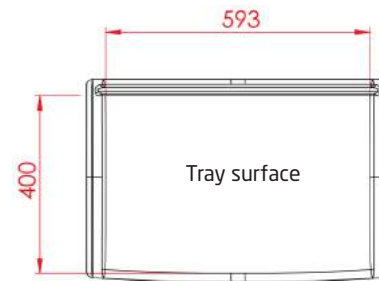

Stock'Ali F600 21G

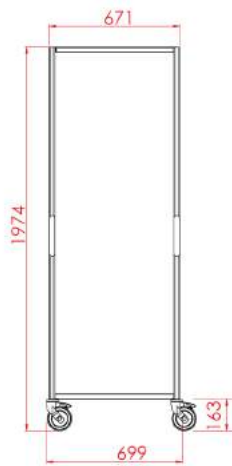

Stock'Ali 2x600 21G

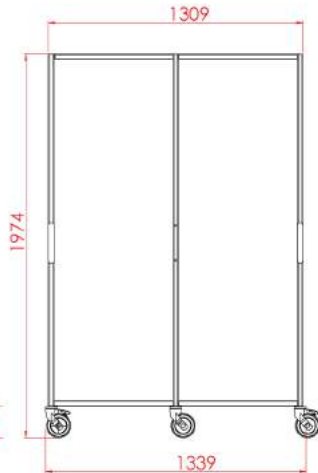

Stock'Ali F1200 Mixte ou F1200

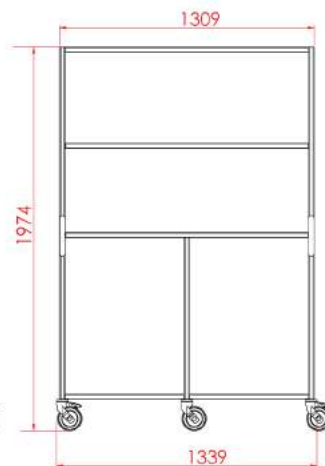

Stock'Ali F400 21G

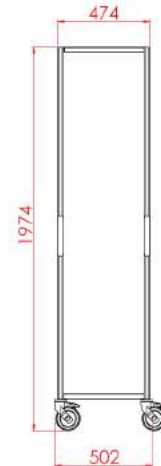

Stock'ALI 2x400 21G

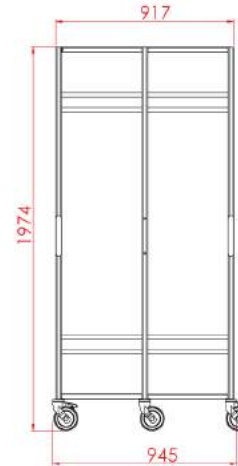

Stock'Ali F600 18G

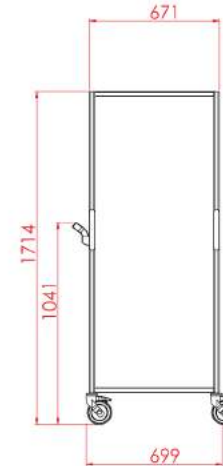

Stock'Ali F600 15G

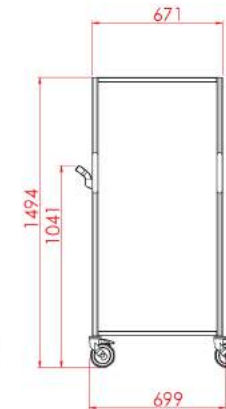

Stock'Ali 9G

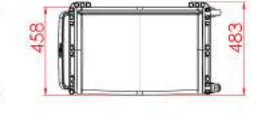
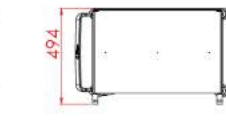
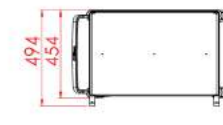
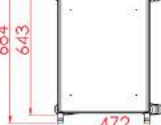
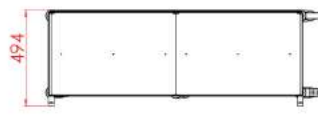
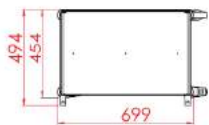
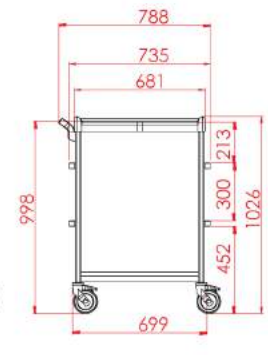

# Summary Options

Summary

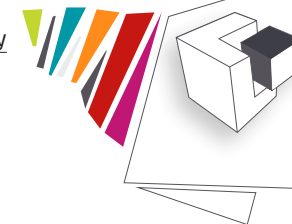

	Materials	Weight (kg)	Left side handle	Right side handle	Front handle	Rail attachment accessories	Locking system: Digicode	Central locking bar and seal system
<b>Guéridon Stock'Alli 9G</b>	Steel	13 kg	option	option	No	option (x4)	No	option
<b>Mod'Alli 9G</b>	Aluminium	18Kg	Standard	option	No	Standard (x4)	option	option
<b>Mod'Alli 9G + CTSP0</b>	Aluminium	22Kg	No	Standard	No	Standard (x4)	option	option
<b>Mod'Alli 12G</b>	Aluminium	18Kg	Standard	option	No	Standard (x4)	option	No
<b>Mod'Alli 15G</b>	Aluminium	22Kg	No	No	No	Standard (x4)	option	No
<b>Mod'Alli 21G</b>	Steel	45Kg	No	No	No	No	No	No
<b>Mod'Alli 21G F400</b>	Steel	50Kg	No	No	No	No	No	No
<b>Logist'Alli 9G</b>	Aluminium	22Kg	Standard	option	No	Standard (x4)	Standard	No
<b>Logist'Alli 9G + CTSP0</b>	Aluminium	25Kg	No	Standard	No	Standard (x4)	Standard	No
<b>Logist'Alli 15G</b>	Aluminium	27Kg	No	No	No	Standard (x4)	option	No
<b>Motorised Logist'Alli 18 drawer tracks</b>	Steel	60Kg	No	No	No	No	No	No
<b>Logist'Alli 20G</b>	Steel	50Kg	No	No	No	No	option	No
<b>Logist'Alli 20G F400</b>	Steel	56Kg	No	No	No	No	option	No
<b>Stock'Alli F600 21G</b>	Steel	20Kg	No	No	option	No	No	No
<b>Stock'Alli 2xF600 21G</b>	Steel	40Kg	No	No	option	No	No	No
<b>Stock 'Alli F400 21G</b>	Steel	24Kg	No	No	option	No	No	No
<b>Stock'Alli 2xF400 21G</b>	Steel	48Kg	No	No	option	No	No	No
<b>Stock'Alli F1200</b>	Steel	28Kg	No	No	option	No	No	No
<b>Stock'Alli F600 15G circulation</b>	Steel	20Kg	Standard	option	option	No	No	No